

Sandringham 21 Bath 170x70cm 2 Tapholes With Handgrips And Tread pattern

ILLUSTRATED

- E0284** Sandringham 21 170cm x 70cm 2 taphole bath with chrome plated handgrips and tread pattern
- B3309** Sandringham SL 21 2 hole bath filler
- S1019** Sandringham 21 front bath panel 170cm
- S1020** Sandringham 21 end bath panel 70cm
- S8970** Trap 1½" plastic P with 75mm seal, multi-purpose outlet suitable for plastic and BS copper pipe
- S8830** Waste 1½" bath chain and overflow, plastic plug
- A5901** TMV thermostatic mixing valve, 22mm

ILLUSTRATED PRODUCT DETAILS







Weights

- E0284** 20.00 KG
- B3309** 1.68 KG
- S1019** 3.60 KG
- S1020** 1.80 KG
- S8970** 1.00 KG
- S8830** 1.78 KG
- A5901** 0.60 KG

Materials

- E0284** Idealform
- B3309** Chrome Plated Brass
- S1019** Acrylic
- S1020** Acrylic
- S8970** Plastic
- S8830** Mixed Material
- A5901** Chrome Plated Metal

Finishes

- E0284**  White (01)
- B3309**  Chrome (AA)
- S1019**  White (01)
- S1020**  White (01)
- S8970**  Neutral / No Finish (67)
- S8830**  Chrome (AA)
- A5901**  Chrome (AA)

Capacity

- E0284** 174.0 litres (to overflow)

Flow rates

- B3309** 70 Litres per minute @ 3 bar pressure

Standards

Constructed to EN 198:2008. EN 14516

Special Notes

The tread pattern on Sandringham 21 baths should not be considered as a fully anti-slip surface and will not prevent all slipping. Frame and supports inclusive. Consideration should be given to safe hot water delivery and the use of an appropriate temperature reduction device, see A5901AA or Part G for guidance.

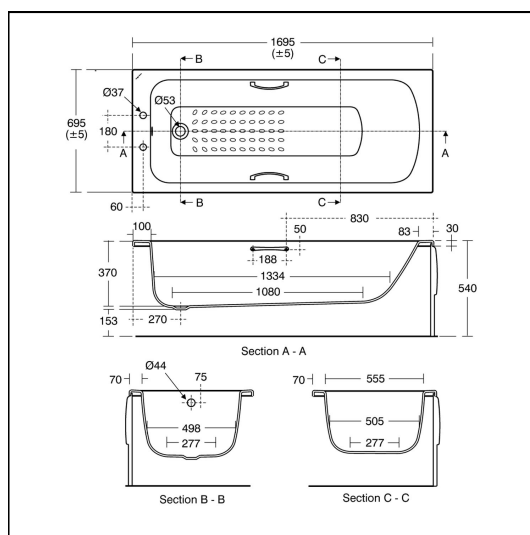

ACCREDITATIONS

E0284(01)

Unified Water Label  174.0 Litres

B3309(AA)

Unified Water Label  70.00 Litres Per Minute

FEATURES

