

atlantic

Experts in **Electric Heating and Hot Water**

 GROUPE
ATLANTIC
UK, ROI & NORTH AMERICA DIVISIONS

GALAPAGOS VERTICAL

THERMOFLUID ELECTRIC RADIATOR



atlanticheat.co.uk |     

TOTAL ELECTRIC SOLUTIONS.

Contents

Warning	2
Declaration of conformity	4
Installation and Servicing	5
Preparing to install the appliance	5
Mounting the wall bracket - Horizontal and Low models	7
Removing the wall brackets - Vertical model	8
Mounting the wall brackets - Vertical model	9
Changing the position of the control panel - Vertical model	10
Mounting and locking the appliance on the wall brackets - Vertical model	16
Mounting and locking the appliance on the wall bracket - Horizontal and Low models	17
Maintenance	18
Recycling	18
Explore	19
Operation of the panel	19
Switching the appliance on/off	20
Operating principle	20
Consumption indicator	21
Heating indicator	21
Initial set-up	22
Use	24
Changing the temperature	24
Changing the schedule	25
Locking access	27
Advanced functions	28
Smart features	28
Prolonged absence	29
Information	29
Parameters	30
Controlling the appliance from a smartphone	30
Open window function	31
Calibration	32
Load shedding	32
Troubleshooting	33
Specifications	35

Warning

Caution hot surface.



CAUTION: Certain parts of this product can become very hot and cause burns. Particular attention must be paid in the presence of children and vulnerable individuals.

- This appliance must be kept away from children under the age of 3, unless under constant supervision.
- Children aged between 3 and 8 may only switch the appliance on or off, on condition that it is placed or installed in a normal, intended position and that the children are supervised or have received instructions concerning the safe use of the appliance and clearly understand the potential hazards. Children aged between 3 and 8 must not connect, adjust or clean the appliance or perform user maintenance.
- This appliance can be used by children aged from 8 years and above and persons with reduced physical, sensory or mental capabilities or lack of experience and knowledge if they have been given supervision or instruction concerning use of the appliance in a safe way and understand the hazards involved. Children must not play with the appliance. Cleaning and user maintenance must not be performed by children without supervision.
- This appliance must only be connected by an authorised person in accordance with the rules and standards in force.
- If the power cable is damaged, it must be replaced by the manufacturer, its customer service or a professional with similar qualification to prevent any hazards.
- The user manual for this appliance can be obtained on the website or from the After-Sales service.
- When the appliance is heated for the first time, a slight odour may be noted. This is caused by the evacuation of any traces linked to the manufacture of the appliance.

- Our devices are incompatible with energy management systems or load shedding systems with a shut-off function. They will damage the thermostat.
- Maintain the minimum distances from furniture when positioning the appliance. Do not install shelves above vertical appliances.
- The appliance is filled with a heat-conducting fluid hazardous to health if ingested. In case of leaks, please contact your installer and take all precautions to prevent any ingestion of fluids by users, especially young children and vulnerable individuals.
- This heating appliance is filled with a precise quantity of a special oil. Repairs requiring the oil reservoir to be opened must be performed only by the manufacturer or its After-Sales service, which should be contacted in case of oil leaks.
- When disposing of the heating appliance, please comply with the regulations concerning oil disposal.
- Do not install the appliance directly under a power outlet.
- An appliance with suspected damage must remain available in situ for assessment by insurance experts. The owner must inform their insurer. Any replacement must be agreed by the insurer.



To prevent overheating, and for safety reasons, do not cover the heating appliance.

Declaration of conformity

RED 2014/53/EU

Hereby, Groupe Atlantic Industrie declares that the radio equipment type Radiator with HE3Z board is in compliance with directive 2014/53/EU. The full text of the EU declaration of conformity is available at the following internet address <https://www.atlantic.fr/Declaration-conformite-UE-RED>.

Description:	Radiator with HE3Z board
Models:	RFM6H - RFM6V - RFM6B

Specifications:

Radio frequency bands used by the Transmitter-Receiver:

2400 MHz to 2483.5 MHz

Maximum radio frequency output: <10 mW

Operating temperature: Min. 0 °C; max. +35 °C.

Class 2 radio equipment: can be marketed and commissioned without restriction.

Radio range: from 100 to 300 metres in free field, variable depending on the linked equipment (the range may be affected by the installation conditions and the electromagnetic environment).

Compliance with the Radio and Electromagnetic Compatibility standards has been checked by the following notified body (no. 0081): LCIE France, Fontenay-aux-Roses.

Installation and Servicing

PREPARING TO INSTALL THE APPLIANCE



As the appliance is heavy, we recommend that two people perform installation.

Do not use the wheel to lift the appliance.

Installation rules

- This appliance has been designed for installation in a residential setting.
- Installation must be carried out in accordance with good industry practice, and with the standards in force in the country of installation.
- The appliance must be connected to a 230 V / 50 Hz single-phase power supply.
- Connection must be made in a way that allows complete isolation of the electrical supply such as a double pole switch having a 3mm (1/8") contact separation in both poles. The means of isolation must be accessible to the user after installation. A fuse is required based on the rating of the appliance.
- In wet environments such as bathrooms and kitchens, the connection box must be installed at least 25 cm from the floor. The installation must be equipped with a 30 mA protective residual current device.

Keep the appliance out of the way of any air currents that might disrupt its operation (e.g.: under a ventilation system, etc.).

- The appliance must be installed in such a way that the switches and other control devices cannot be accidentally touched by anyone in the shower or bath.
- Installing an appliance at altitude causes an increase in the air outlet temperature (10°C per 1000 m change in altitude). It is highly inadvisable to fit appliances above an altitude of 1000 m (risk of malfunction). The appliance is not for use above altitude of 2000m.
- It is prohibited to fit a vertical appliance horizontally, and vice-versa.
- Maintain the minimum distances from furniture when positioning the appliance. Do not install shelves above vertical appliances.

Do not install it directly under a power outlet.

Your appliance may be installed in area 2 of the bathroom.
 For safety reasons, it must not be installed in area 0 or 1.

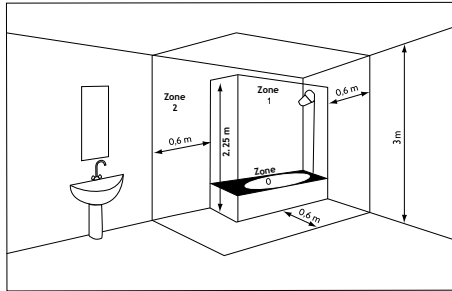

Required clearance:

Horizontal and Low models

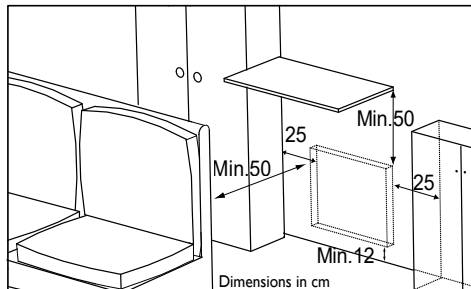

Vertical model

Vertical 1000 W

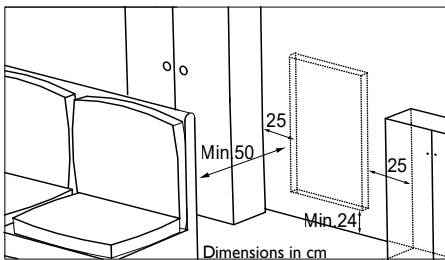

Vertical 1500 W / 1800 W

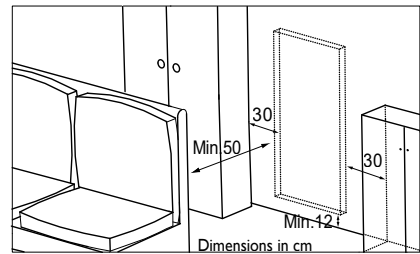

To optimise the presence detection of your appliance, avoid installing it in a tight corner, or behind a piece of furniture.

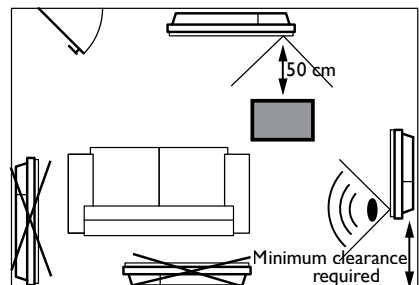

MOUNTING THE WALL BRACKETS - HORIZONTAL AND LOW MODELS

 Obtain suitable plugs and screws for your type of wall, with a minimum load capacity of 40 kg per mounting point (*screws and plugs not supplied*).

1 Place the bracket on the floor and against the wall.



2 Locate the drilling points **A**.
The drilling points **A** indicate the position of the upper mountings.

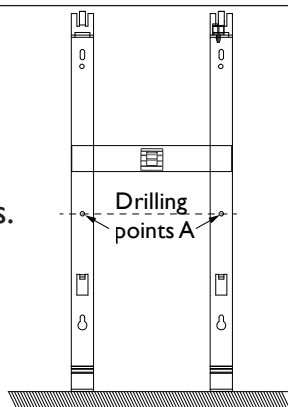

3 Refit the wall bracket by aligning it with the drilling points **A** to locate the other drilling points **B**.

The other drilling points **B** indicate the position of the upper mountings.

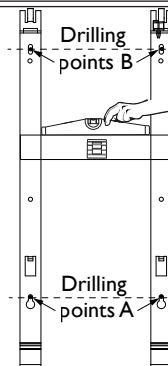

4 Drill the 4 holes and insert plugs.
Use suitable plugs for your type of wall.

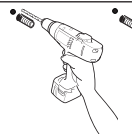

5 Position the wall bracket and screw it in.



REMOVING THE WALL BRACKETS - VERTICAL MODEL

- 1 Leave the radiator flat on the ground.
- 2 Open the flaps at the base of the box.
- 3 Remove the blocks from the centre of the radiator and leave the others on the radiator.
- 4 Move the upper and lower blocks approximately 5 cm to gain access to the wall brackets.
- 5 Remove the 2 bolts from each wall bracket using the key provided at the back of the control panel (*these 4 bolts are not used again*).

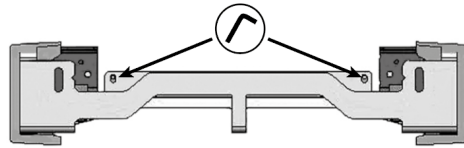

- 6 Unclip the plastic covers at the ends of the wall brackets. These must be retained.

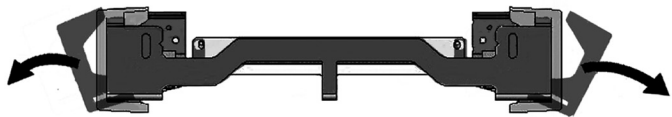

- 7 Remove the top wall bracket and the bottom wall bracket. These must be retained.

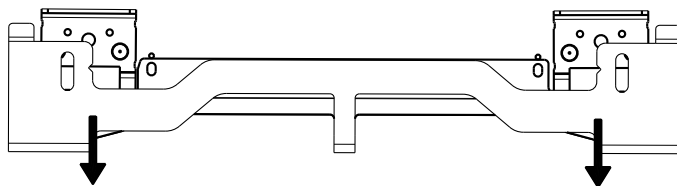

MOUNTING THE WALL BRACKETS - VERTICAL MODEL

Use the correct screws and wall plugs for your support (concrete, plasterboard, etc.).

Use the installation template provided.

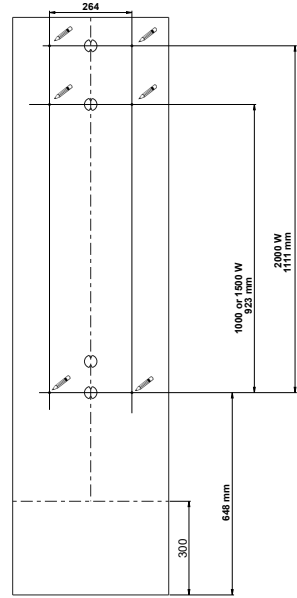

1 Before screwing, align the bottom wall bracket marks with the 2 screws.

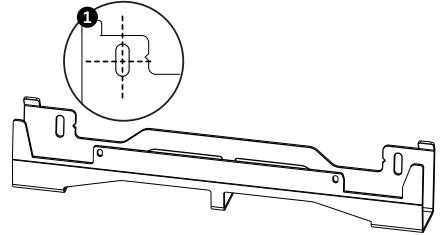

2 Make sure that the brackets are level.

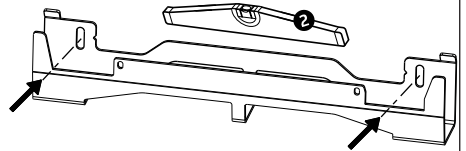

3 Screw in the brackets.

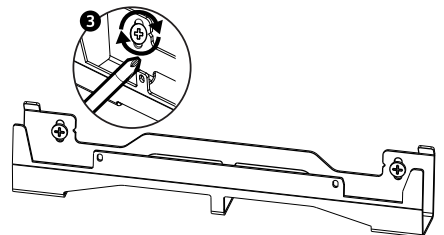

CHANGING THE POSITION OF THE CONTROL PANEL - VERTICAL MODEL

By default, the vertical radiator's control panel is positioned on the right (*wall-mounted appliance*).

On this model, you have the option to position the panel on the left. To do so, carry out the following operations:

 Operations to be performed with the power off, radiator flat and facing downwards with its blocks moved 5 cm out.

Use the key supplied with the radiator. 

Rear views

1 Remove and keep the 4 mounting screws from the rear of the control panel bracket.

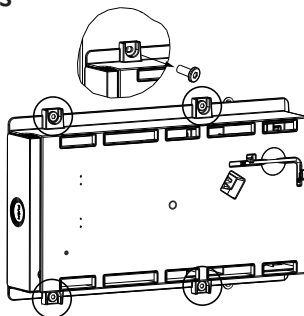

2 Swivel the panel bracket a half-turn to the right and downward.

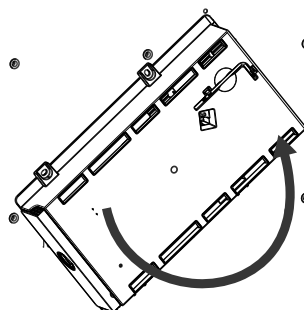

3 Mount the panel bracket using the 4 screws.

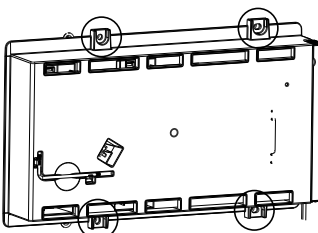

④ Position the radiator in its 2 blocks, on the side opposite the panel.

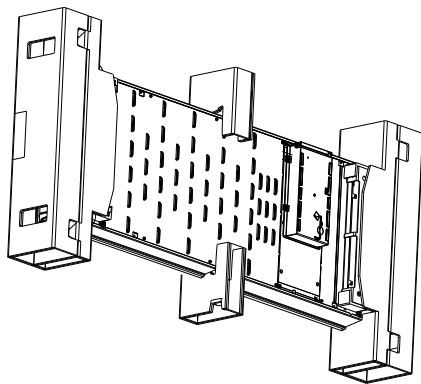

Front views

⑤ Press on the side of the panel to release it from the bracket.

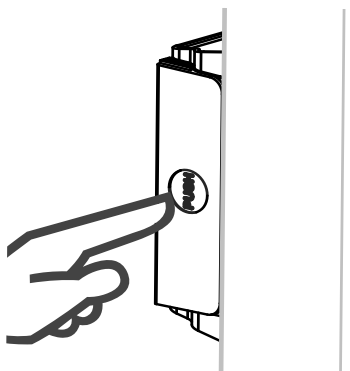

⑥ Pull on the side of the panel so that it is completely visible.

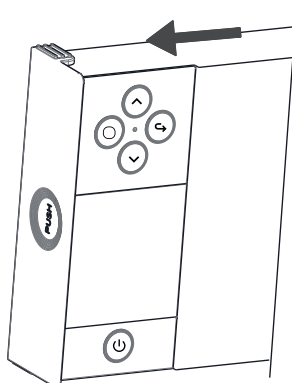

Rear views

7 Remove and keep the two mounting screws on the rear part of the control panel.

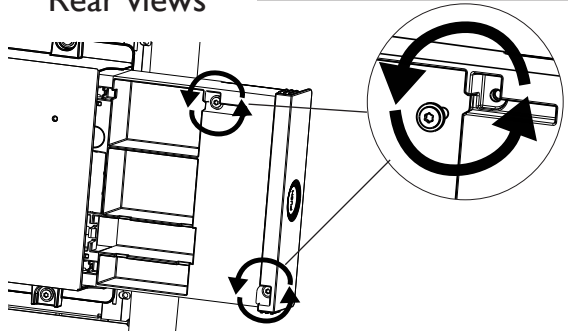

Front views

8 Pull gently on the front part of the control panel to release it.

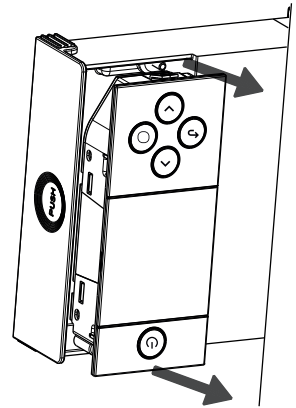

9 Swivel and screw back in. Reverse the direction of the panel cable and refit it.

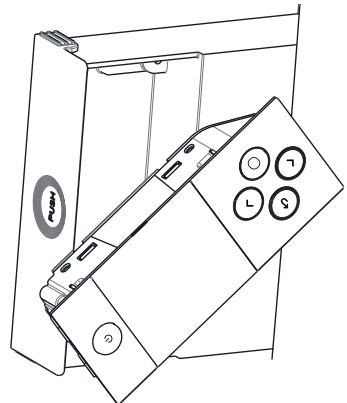

⑩ Reposition the front part in the rear part of the control panel.

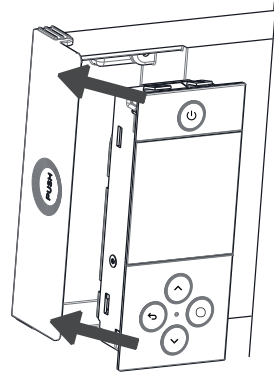

Rear views

⑪ Refit the two mounting screws on the rear part of the control panel.

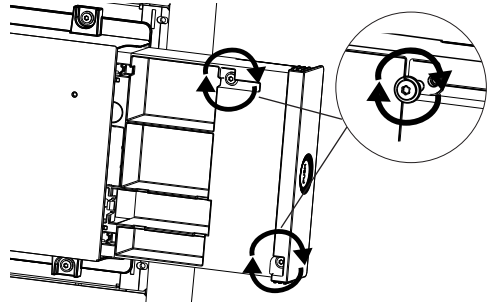

⑫ Press on the side of the panel to insert it into the bracket.

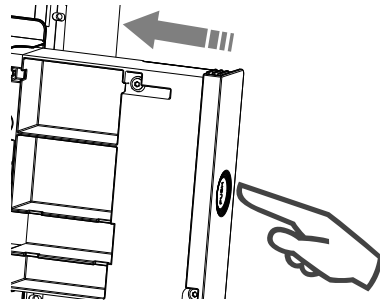

CONNECTING THE APPLIANCE



Vertical model

If the electrical connection box is situated above the bottom wall bracket, insert the power cable into the bracket to make the connection. This way you will prevent cable pinching.

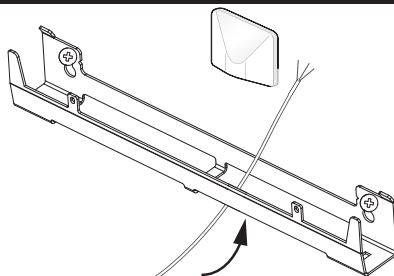

Horizontal and low models

If the cable is too long, use the cable guide situated on the wall bracket.

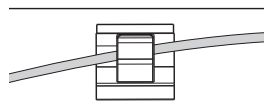

Connection rules

- The appliance must be connected to a 230 V / 50 Hz single-phase power supply.
- The appliance will be connected to the mains by means of the appliance cable via a connection box.
- **Earthing is prohibited. Do not earth the pilot wire (black wire).**
- There must be a way of disconnecting provided in the fixed pipes, in line with the installation rules.
- If the power cable is damaged, it must be replaced by the manufacturer, its After-Sales service or a similarly qualified professional to prevent any hazards.
- If using the pilot wire, and if it is protected by a 30 mA residual current device (e.g. bathroom), the pilot wire power supply needs to be protected on this RCD.
- If you wish to use a load-shedding device, select one with a pilot wire output and not with a power output, to avoid damage to the thermostat.

Appliance connection diagram

- Shut off the power, and connect the wires as shown in the diagram below:

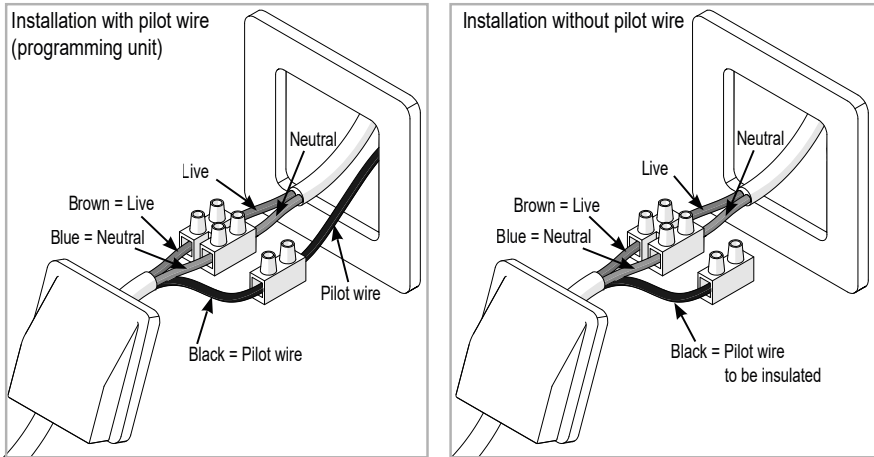

- You can connect the pilot wire if your house is equipped with a programming unit, an energy programmer or an energy manager.

MOUNTING AND LOCKING THE APPLIANCE ON THE WALL BRACKETS - VERTICAL MODEL

❶ Place the radiator on the floor in front of the wall brackets.

❷ Lift the radiator so as to mount its lower hooks on the bottom wall bracket.

❸ Move the top of the radiator toward the top wall bracket until it makes contact.

❹ Lift the radiator slightly while keeping it straight.

❺ Move the top of the radiator towards the wall.

❻ Gently lower the radiator.

❼ Mount the upper hooks on the top wall bracket, and the lower hooks on the bottom wall bracket.

❽ Lock the radiator on the brackets, clipping on the 4 plastic guards to ensure it is securely fixed.

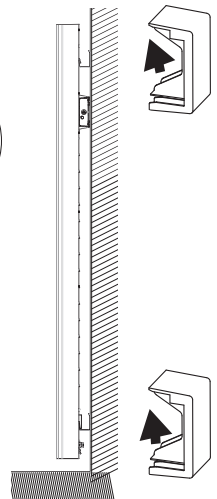
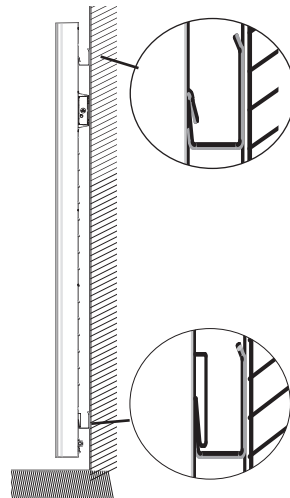
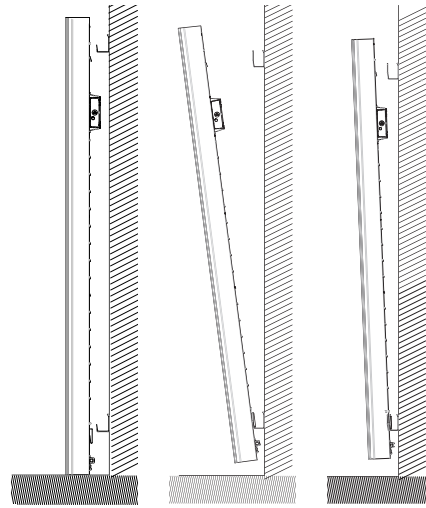

MOUNTING AND LOCKING THE APPLIANCE ON THE WALL BRACKET - HORIZONTAL AND LOW MODELS

① Place the radiator on the lower part of the wall bracket.

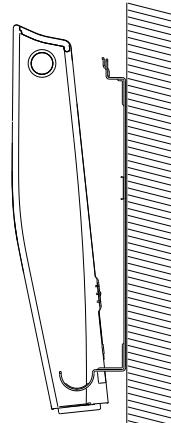

② Bring the radiator towards the upper part of the bracket, and then lift it to insert the bracket into the radiator holes.

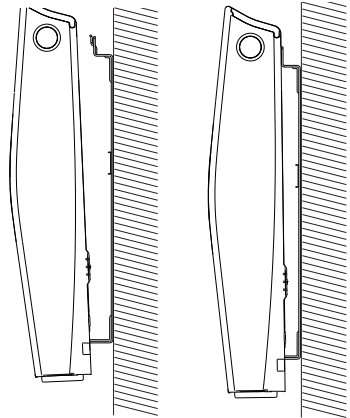

③ Turn the screw using a screwdriver.

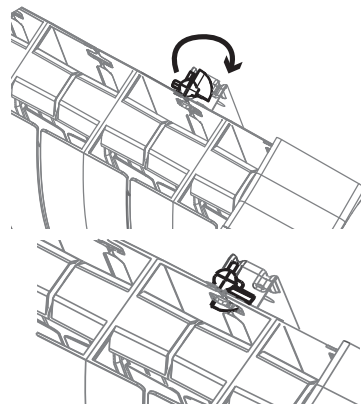

MAINTENANCE

Before any maintenance work, cut the power supply to the appliance. To maintain the appliance's performance, it needs to be dusted approximately twice a year.

Never use abrasive products or solvents.

This heating appliance is filled with a precise quantity of a special oil. Repairs requiring the oil reservoir to be opened must be performed only by the manufacturer or its After-Sales service, which should be contacted in case of oil leaks.

When disposing of the heating appliance, please comply with the regulations concerning oil disposal.

RECYCLING



Appliances carrying this symbol must not be disposed of with household waste. They must be collected separately and recycled.

Products at the end of their life must be collected and recycled in accordance with the local provisions and decrees.

Explore

OPERATION OF THE PANEL

HORIZONTAL AND LOW MODEL

Remove the flap to access the screen.

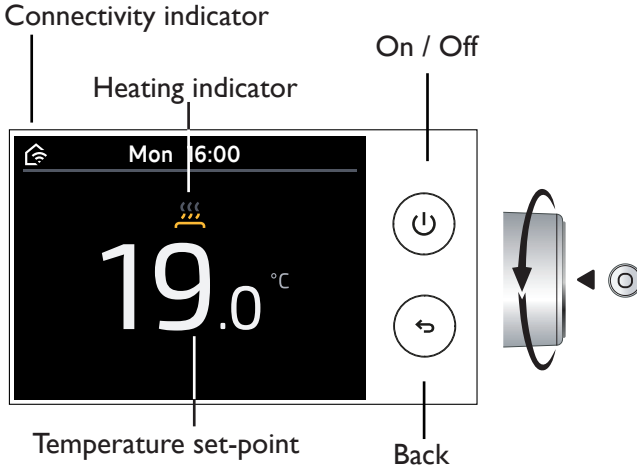

- Setting the temperature / Navigating
- Confirm / Menu / Lock: press the centre of the control knob

VERTICAL MODEL

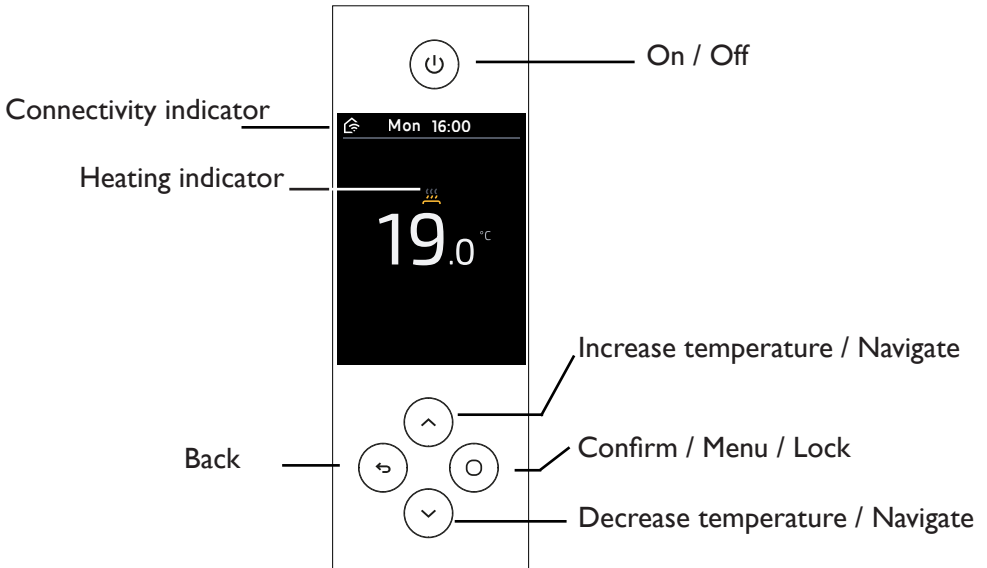

SWITCHING THE APPLIANCE ON/OFF

To switch your appliance on, use .

To switch your appliance off temporarily, use  (long press).

For an extended shutdown (outside of heating periods), use the switch on the right-hand side of your appliance.

Move it to  to switch power to the appliance off.

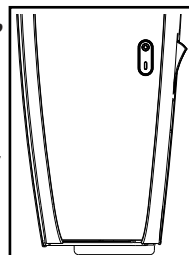

When the appliance is switched off, it may be necessary to reset the day and time (if off for more than 1h 45 mins).



To restart your appliance, move the switch to .

OPERATING PRINCIPLE

Your appliance has a default heating schedule, as set out below:



 Presence	When you are present , the default set temperature is 19°C . The default set schedules are: - Monday to Friday: from 05:00 to 09:00 and from 17:00 to 23:00 - Saturday and Sunday: from 05:00 to 23:00
 Daytime absence	When you are absent during the day, the default set temperature is 15.5°C . The default set schedules are: - Monday to Friday: from 9:00 to 17:00
 Night	At night , the default set temperature is 17°C . The default set schedules are: - Monday to Sunday: from 23:00 to 5:00.

You can change this schedule to adapt it to your lifestyle.
This schedule can be activated or deactivated.

CONSUMPTION INDICATOR

A consumption indicator allows you to optimise your temperature setting. When the consumption indicator is on the green symbol, you are at a temperature level equal to or less than the recommended temperature.

HEATING INDICATOR

	The appliance is heating up to reach the set temperature.
	The appliance is heating up to maintain the set temperature.
	The appliance does not heat up.



Initial set-up

You have a Horizontal or Low model:

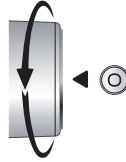
Turn the control knob to navigate,
Press the control knob to confirm.



You have a Vertical model:

Use the  or  key to navigate, and confirm by pressing .

- **Select the language.**



- **Set the date and time.**



- **Follow the instructions to set up your radiator.**

You will then customise your schedule to your life rhythm.



- When do you usually sleep (what time do you get up and go to bed)?
- What days are you absent during the day?
- On these days, what time are you absent?
- On these days, are you present between 12:00 and 14:00?
- And, lastly, you can choose the temperature that you want when you are present (set to 19°C by default), when you are absent (set to 15.5°C by default), and at night (set to 17°C by default).

If you do not want to set a schedule, the smart functions will be inactive, and the temperature setpoint will be 19°C.

You will not have access to the energy saving functions.

You will also be able to configure the smart functions on your appliance:

- Activate the adaptive scheduling so that your appliance registers when you are present and absent and automatically creates a schedule to suit your life rhythm.
- Activate the advance room heating so that the room reaches the right temperature at the right time.

If this function is active, the appliance starts heating the room ahead of the scheduled time, so that it reaches the correct temperature.

If this function is not active, the appliance will start to heat the room at the scheduled time.

- Manage unscheduled periods when you are unexpectedly present or absent. If this function is active, the temperature will be temporarily adjusted when you are unexpectedly absent (lowering the temperature) or present (starting heating automatically).

If this function is not active, the temperature will not change, even if you have returned unexpectedly.

Example with the function on:

1. You have scheduled an absence during the day but your appliance detects your return, and starts heating.
 2. You are scheduled to be present and are not, and your appliance reduces its setpoint temperature.
- Activate the open window detection so that your appliance will stop when it detects a drop in temperature.

You can start to set up your appliance at a later time by accessing the menu.

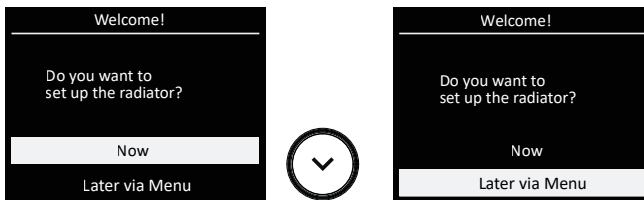

In this case:

- The adaptive scheduling is active;
- The advance heating is inactive;
- Unexpected absence/presence is active;
- The temperatures are set by default to 19°C when present, 15.5°C when absent, and 17°C at night;
- Open window detection is active.

CHANGING THE TEMPERATURE

The schedule is inactive: the new temperature will be applied at all times.

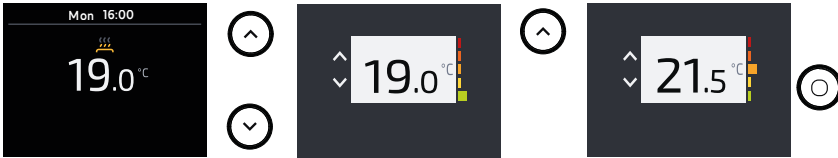

The schedule is active:

- The new temperature will be applied temporarily until the next time slot change (daytime presence or absence, night).

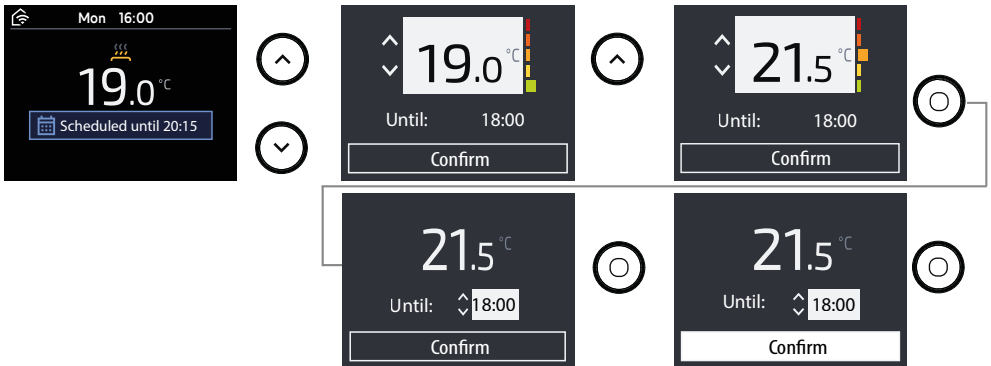

- By setting it via the Menu, the new temperature will be applied the entire time, during daytime periods of presence and absence and at night.

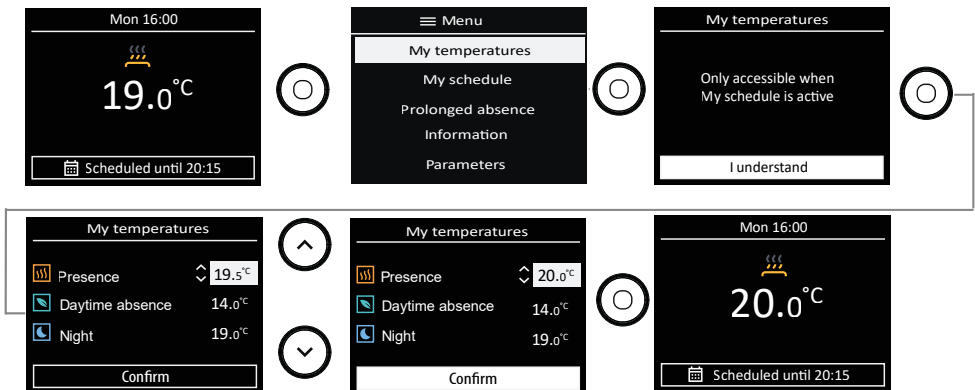

CHANGING THE SCHEDULE

You can change the daytime presence and absence and night time slots for each day of the week.

Changing a day:



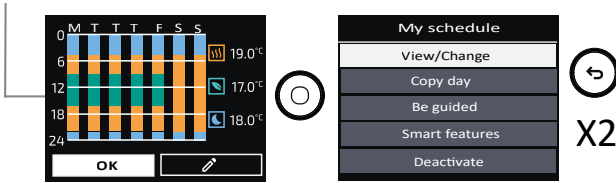

Copy this day to one or more days of the week:

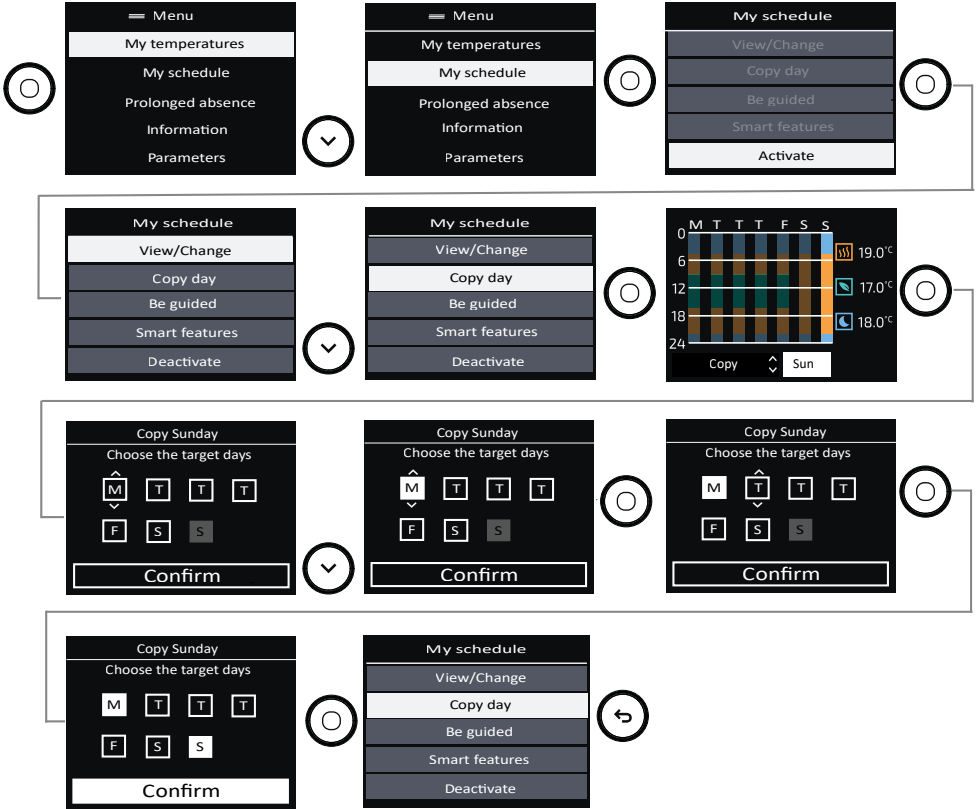

Be guided:

You can customise your schedule to match your life rhythm (if you did not do this during set-up or if you want to make changes).

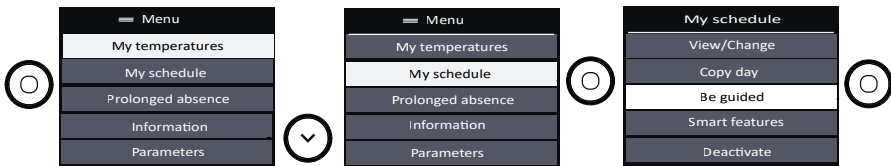

LOCKING ACCESS

To prevent them being played with by children, you can lock access to the controls for your appliance by pressing and holding the control knob (Horizontal and Low models) or pressing and holding  (Vertical model).

The procedure is the same to unlock the controls.

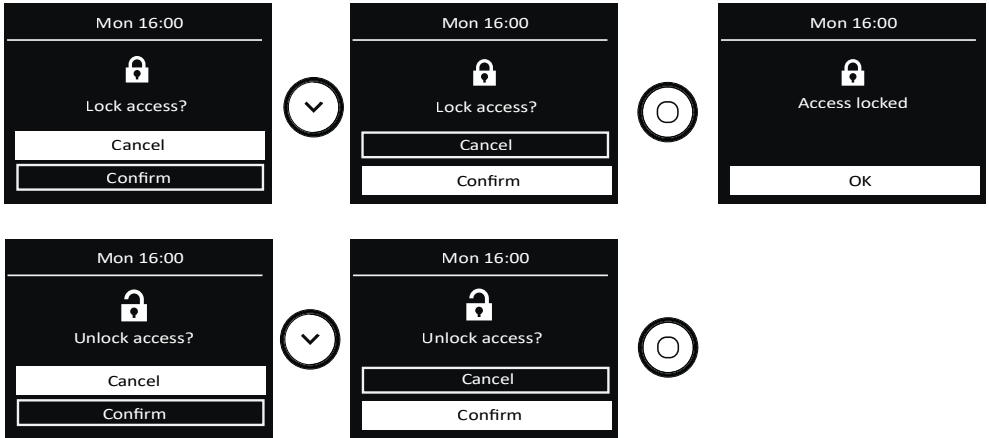

Advanced functions

SMART FEATURES

In the Schedule menu, you can choose the Smart functions:

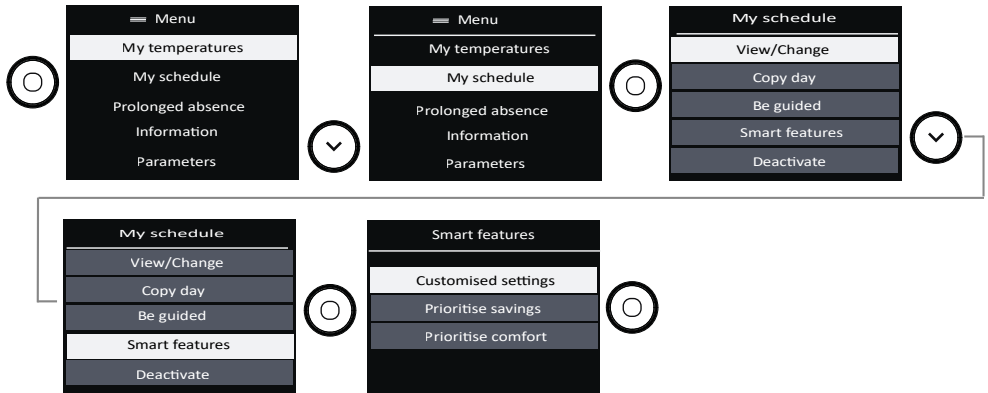

Customised settings:

- Adaptive scheduling: The schedule is adapted based on the detected absences and presences.
- Advance heating: the appliance starts heating in advance (the room is at the correct temperature at the scheduled time).
- Unexpected event response: the temperature is temporarily adjusted when you are present or absent unexpectedly.
- Presence detection functions are inactive during the scheduled night hours.

Prioritise savings:

- Adaptive scheduling: The schedule is adapted based on the detected absences and presences.
- Advance heating: the appliance does not start heating in advance (heating starts at the scheduled time).
- Unexpected event response: the temperature is temporarily adjusted when you are present or absent unexpectedly.
- Presence detection functions are inactive during the scheduled night hours.

Prioritise comfort:

- Adaptive scheduling: The schedule is adapted based on the detected absences and presences.
- Advance heating: the appliance starts heating in advance (the room is at the correct temperature at the scheduled time).
- Unexpected event response: the temperature is temporarily adjusted when you are present or absent unexpectedly.
- Presence detection functions are inactive during the scheduled night hours.

PROLONGED ABSENCE

The Prolonged absence function allows you to select the desired temperature when you are away, and set the duration of your absence.

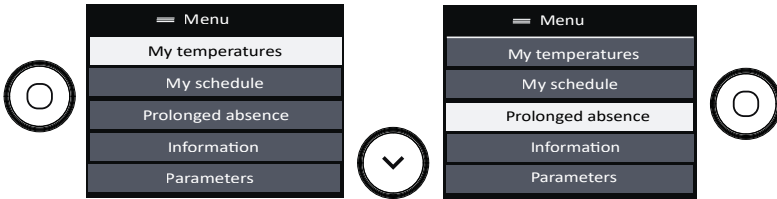

- Set the desired temperature during your prolonged absence.
- Set the start date and time and the end date and time for the absence.
- You have the option to view and change this information.
- You can also delete this prolonged absence.

INFORMATION

Various information can be accessed in this menu.

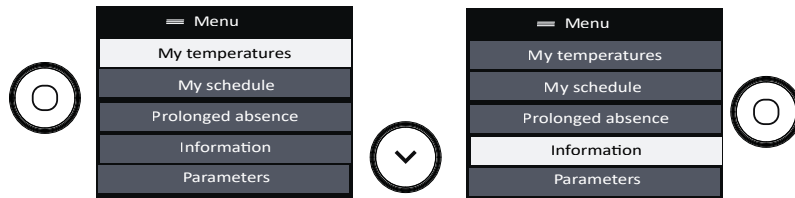

- The information on the consumption in kWh can be viewed.
The meter starts when the appliance is first set up.
The meter can be reset.
- The information on the energy savings can be set. With the schedule active, you can see that the schedule has allowed you to save xx% of the time. This information is available after 24 hours of use.
- You can view the information relating to your appliance: reference, brand, model, output, serial no. (useful when contacting After-Sales)
- You can find the manual online by scanning the QR code.

PARAMETERS

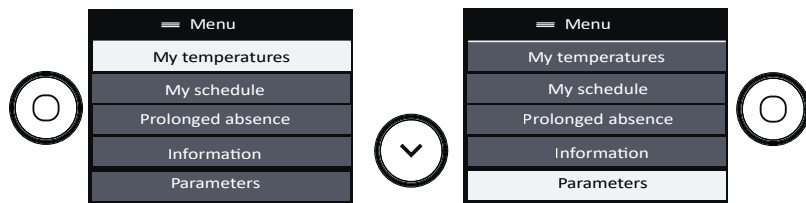

- **Connectivity:** you can view the signal strength, and see if the connection is established or failed.
- **Accessibility:** you can manage the key presses, key-press sounds and brightness of the screen.
- **Language:** you select your choice of language.
- **Date and time:** you can update the date and time.
- **Window open:** you can activate or deactivate the function.
- **Calibration:** you can set the difference between the room temperature and the value set on your appliance.

CONTROLLING THE APPLIANCE FROM A SMARTPHONE

This appliance is compatible with our Cozytouch® offer.

Accessories required:

- IOS- and Android-compatible Cozytouch application. Free to download from the App Store or Google Play;
- The Cozytouch HUB, sold by distributors of our brand and on our website;
- Internet router or hub.



This installation will enable you to control, program and monitor your appliance(s) remotely, via a smartphone or tablet.

For example, you can change the setpoint temperature, manage your absences by indicating your return date, display the consumption of your appliances, change mode, or enter your programming.

Connecting your appliances:

All connection or control operations are carried out via the app
(follow the instructions on-screen on your smartphone or tablet).

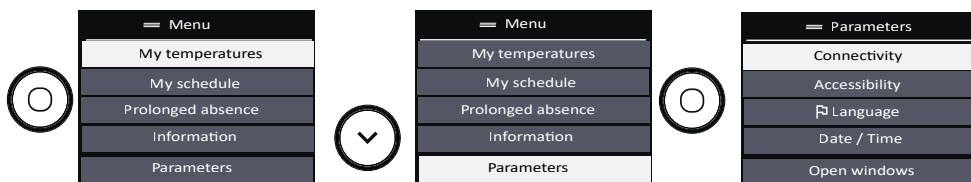

OPEN WINDOW FUNCTION

The open window function detects temperature variations linked to the opening and closing of your windows. If you forget to switch your appliance off when a window is open for a long period of time, this function solves this issue, and prevents your appliance from heating unnecessarily.

The appliance automatically switches to frost protection mode (7°C) if it detects an open window and then climbs back to the original temperature when it detects it closing (the detection time is variable, and can take up to 15 minutes).

The appliance reacts to opening and closing of windows according to several variables: the required temperature in the room, the outside temperature, the configuration of the installation.

We advise against using this function in corridors and in rooms situated close to an entrance door leading to the outside.

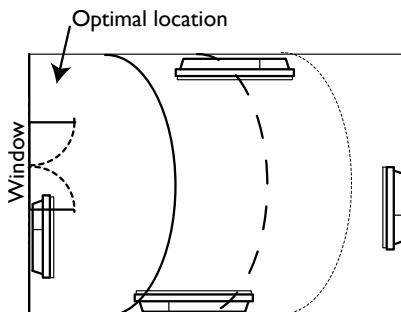

To activate or deactivate the function, access the Parameters menu:

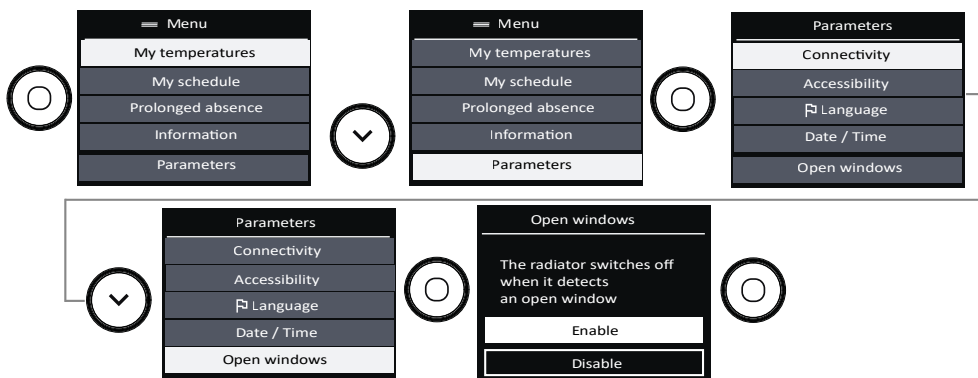

When the function is active, and the appliance detects an open window, it displays the following message:

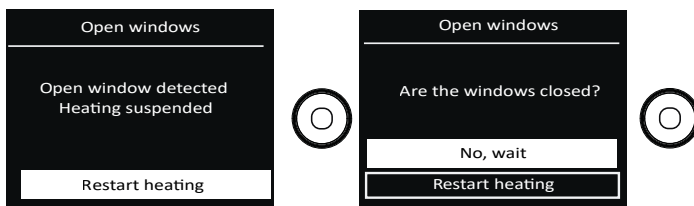

CALIBRATION

Calibrate the temperature on your appliance so that it matches the room temperature.











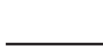





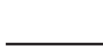

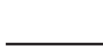

LOAD SHEDDING

Our devices are compatible with various load shedding systems. However, you must not use mains shut-off load shedding, since these systems are incompatible with our devices. Sudden, inadvertent and repeated power shut-offs can cause premature wear and damage to the electronics boards, which would not be covered by the manufacturer's warranty. During load shedding periods, the screen shows "Prioritized load shedding" if an Off/Load shedding command is sent, and "Priority command" if a frost protection command is sent. The appliance will then return to its initial operation.

Troubleshooting

Problems encountered	Check to make
The control panel screen does not come on.	Check that the switch on the rear or side of the appliance is in position I. Check that the appliance is connected to the power supply.
The appliance does not heat up.	Check that the installation's circuit breakers are engaged or that the load shedder (<i>if present</i>) has not deactivated the heating. If the ambient air temperature in the room is higher than the setpoint temperature, the appliance can be expected not to heat up. Check that your appliance has not been switched to frost protection mode by the pilot wire.
The appliance does not heat up enough.	Increase the temperature. If the setting is at its maximum, make the following checks: - Check whether the power of your appliance is suited to the size of your room (<i>we recommend on average 100W/m² for a height of 2.50 m or 40W/m³</i>). - Check that your appliance only heats the room in question (<i>door closed</i>). - Check the supply voltage to the appliance.
The appliance takes time to heat up.	The electric heater heats up the fluid, which gradually and naturally starts circulating inside the appliance. The fluid's inertia properties mean that the appliance's surface temperature only reaches an optimal level after at least 15 mins, depending on the ambient temperature and losses from the room when the appliance is heating up.
The appliance is heating constantly.	Check that the appliance is not situated in an air current, or that the setpoint temperature has not been increased.
The appliance is heating when the window is open.	There may be a time lag between opening the window and the heating stopping (<i>approx. 15 mins</i>). If this time lag seems too long, you can temporarily switch your appliance off using  .
The appliance is very hot on its surface.	The appliance can be expected to be hot when operating, while the maximum surface temperature is limited in accordance with the NF standard "Électricité Performance" [electrical performance]. If however you feel that your appliance is still too hot, check that the power is suited to the area of your room (<i>we recommend 100 W/m² for a ceiling height of 2.50 m or 40 W/m³</i>), and that the appliance is not placed in an air current which affects its regulation.
Traces of dirt appear on the wall around the appliance.	The dirt is due to poor quality of the ambient air (<i>using a chimney, candles, cigarette smoke, etc.</i>). It is recommended in this case to make sure that the room is properly aerated (<i>ventilation, air intake, etc.</i>). This dirt does not represent grounds to replace the appliance under warranty.

Problems encountered	Check to make																					
The appliance does not follow the Cozytouch app commands.	Check the connection from the app.																					
The appliance does not follow the internal programming commands.	Make sure that the programming unit is being used correctly (see the unit's user manual). Check that the programming commands are correctly transmitted:																					
	<table border="1"> <thead> <tr> <th></th> <th>Comfort</th> <th>Eco</th> <th>Frost Protection</th> <th>Heating off Load shedding</th> <th>Comfort -1 °C</th> <th>Comfort -2 °C</th> </tr> </thead> <tbody> <tr> <td>Signal to be transmitted</td> <td></td> <td></td> <td></td> <td></td> <td></td> <td></td> </tr> <tr> <td>Measurement between the Pilot Wire and neutral</td> <td>0Volts</td> <td>230 Volts</td> <td>-115 negative Volts</td> <td>-115 positive Volts</td> <td>230 Volts for 3 s</td> <td>230 Volts for 7 s</td> </tr> </tbody> </table>		Comfort	Eco	Frost Protection	Heating off Load shedding	Comfort -1 °C	Comfort -2 °C	Signal to be transmitted							Measurement between the Pilot Wire and neutral	0Volts	230 Volts	-115 negative Volts	-115 positive Volts	230 Volts for 3 s	230 Volts for 7 s
		Comfort	Eco	Frost Protection	Heating off Load shedding	Comfort -1 °C	Comfort -2 °C															
Signal to be transmitted																						
Measurement between the Pilot Wire and neutral	0Volts	230 Volts	-115 negative Volts	-115 positive Volts	230 Volts for 3 s	230 Volts for 7 s																
In pilot wire or carrier programming, frost protection or load shedding commands have priority.																						
The appliance does not connect to the app.	The maximum range between the Cozytouch HUB and the appliance is 100 to 300 m in free field / 20 m 2 concrete slabs. The maximum number of connectable appliances per room is 5.																					
The appliance is not following my life rhythm	Adaptive scheduling must be active. The appliance needs at least 2 weeks to adapt the schedule to your life rhythm.																					

If you have been unable to solve your problem, contact a professional, after noting the references for your appliance from the nameplate (commercial code, serial no.), the room temperature, and any programming system you are using.

You can also find this information in the Information menu.



Specifications

Model references		RFM6H / RFM6V / RFM6B	
Specification	Symbol	Value	Unit
Heat output			
Rated heat output	P nom	0.7 to 2 700 to 2000	kW W
Minimum heat output	P min	0.7 700	kW W
Maximum continuous heat output	P max,c	2 2000	kW W
Auxiliary electricity consumption			
At rated heat output	el max	0.000	kW
At minimum heat output	el min	0.000	kW
In standby mode	el SB	0.0007 l 0.7 l	kW W
Type of heat output/room temperature control			
Specification	Unit	Additional information	
Electronic room temperature control and weekly timer.	yes		
Other control options			
Room temperature control with a presence detector.	yes		
Room temperature monitoring, with window open detector.	yes		
Remote monitoring option.	yes		
Activation adaptive control.	yes		
Activation period limit.	no		
Black globe sensor.	no		
Contact details	As per nameplate		