



MOULDED WOOD TOILET SEAT HUDSON ULTRA-FIX®

4445CLT000 | 4446CLT000



Features



- Bemis Ultra-Fix® - patented fixing system that will not loosen! Simple, "no mess" installation ensures your seat stays tight on the pan.
- Slow Close - closes slowly and quietly.
- Take off for easier and hygienic cleaning.
- Non-Slip Bumpers - provide extra grip so the seat stays securely on the pan.
- Environmentally Friendly Moulded Wood - made with responsibly sourced woods and water-based paints.
- High density moulded wood is low profile & stylish with non-slip luxury bumpers.
- Adjustable hinge.

4445CLT000 | 4446CLT000

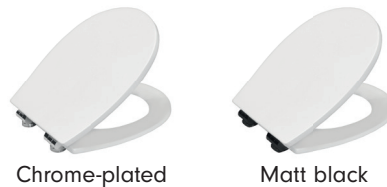
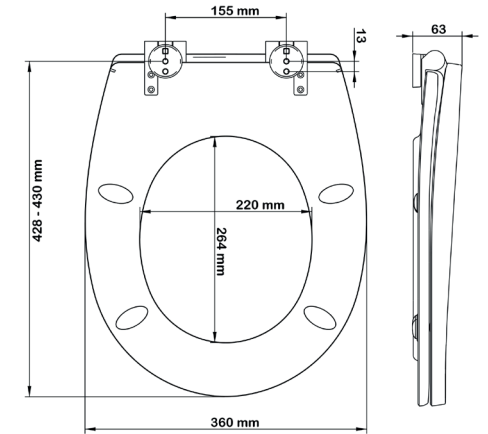

The Bemis high density moulded wood seats are manufactured using a proprietary moulding technique that allows for greater design freedom than traditional compression molding techniques. The moulding process allows for more compression, resulting in less porous, denser seats that match the look and feel of vitreous china.

Name	Part number	Colour	Hinge	EAN	Ring bumper	Cover bumper	Weight	MQ	STD Pallet
Hudson Slow Close, Take Off Ultra-Fix®	4445CLT000	White	Adjustable chrome-plated	5012799282173	4	2	3.31 kg	5	135
Hudson Slow Close, Take Off Ultra-Fix®	4446CLT000	White	Adjustable matt black	5012799282180	4	2	3.31 kg	5	135