

FARMHOUSE FIRE CLAY CERAMIC BELFAST SINK CFBL595WH/

RANGEmaster
sinks & taps



Size: 595 x 455 mm

Created seamlessly to blend modern living with a traditional country kitchen, the Farmhouse Belfast kitchen sink is a stylish alternative to a classic design.

- Reversible installation
- Weir style overflow
- Waste kit included
- 10 year warranty

Material	Fire clay Ceramic
Material Gauge	-
Material Finish Bowl	-
Material Finish Drainer	-
Drainer Position	
Overall Length (mm)	595
Overall Width (mm)	455
Main Bowl Length (mm)	535
Main Bowl Width (mm)	395
Main Bowl Depth (mm)	222
Second Bowl Length (mm)	-
Second Bowl Width (mm)	-
Second Bowl Depth (mm)	-
Tap hole Size (mm)	-
Waste Size (mm)	1 x 60
Waste Kit	Included with sink (1 x 60mm BSW & overflow kit)
Min. Base Unit (mm)	600
Cutout Size Length (mm)	-
Cutout Size Width (mm)	-
Warranty Sinks (years)	0
Product Code	CFBL595WH/
Barcode	5015834049274

Date of download: July 28, 2022

AGA Rangemaster continuously seeks improvements in specification, design and production of products and thus, alterations take place periodically. Whilst every effort is made to produce up-to date resources, the information included here is intended as a guide. Always refer to the product's installation instructions when fitting, installation work should be completed a professional tradesman.

FARMHOUSE FIRE CLAY CERAMIC BELFAST SINK

CFBL595WH/

Technical Drawing

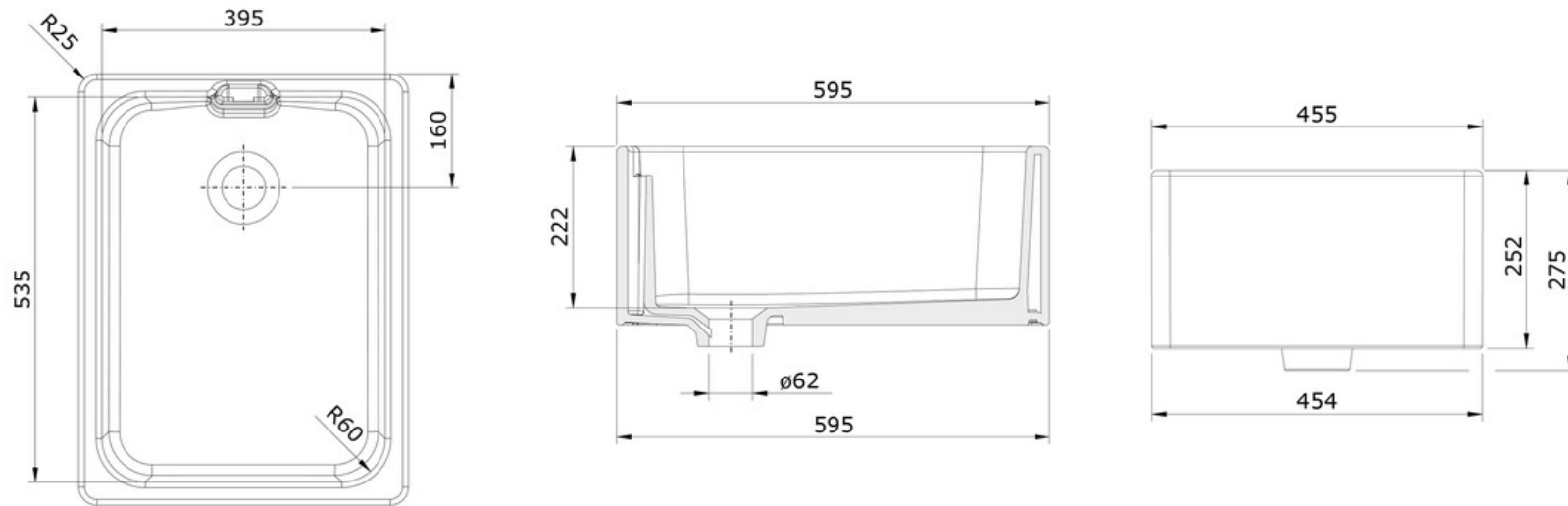

NB: Due to manufacturing processes this sink may have a +/- 5mm tolerance on the measurements.

Date of download: July 28, 2022

AGA Rangemaster continuously seeks improvements in specification, design and production of products and thus, alterations take place periodically. Whilst every effort is made to produce up-to date resources, the information included here is intended as a guide. Always refer to the product's installation instructions when fitting, installation work should be completed a professional tradesman.

FARMHOUSE FIRE CLAY CERAMIC BELFAST SINK
CFBL595WH/