

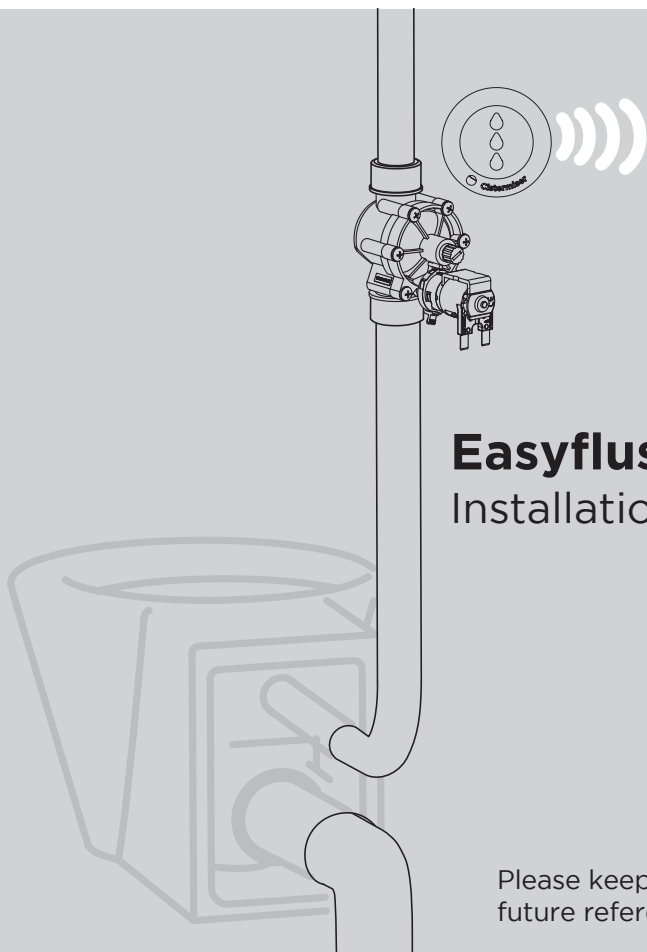

Cistermiser



Easyflush Direct Installation Guide

Please keep this booklet for future reference.

Installer: when you have read these instructions, please ensure you leave them with the user.

1. Introduction

The Easyflush Direct valve provides electronic flushing of the WC without the need for a WC cistern. There are two versions:

Wave mode (standard) is operated by the user bringing their hand towards the infrared sensor. A part flush is triggered by holding the user's hand in place for 1 second; a full flush is triggered by a hand pass of over 1 second. The dual flush setting is a factory default but can be changed by the installer.

Walkaway can be selected as a mode and is activated when the user stands up or leaves the cubicle but it can also be activated by the user bringing their hand toward the sensor. The dual flush setting is a factory default but can be changed by the installer. A part flush is triggered by short user occupancy and a full flush by long user occupancy (over 45 seconds).

With Easyflush Direct there is no cistern to be refilled; this means a second flush can be activated without a delay. The product includes a hygiene rinse function.

Supplied parts

- 1 Sensor unit
- 2 Valve unit
- 3 Sensor nut
- 4 Sensor rubber gasket
- 5 Clamp plate
- 6 DC pipe interrupter inc. flow regulator
- 7 Valve rubber seal
- 8 Adapter 1" to 3/4"
- 9 Cap seal
- 10 Cap washer
- 11 Cap nut
- 12 Long screws
- 13 Short screws
- 14 Sticky pad
- 15 6mm screw packer
- 16 1.5m extension cable
- 17 Mains transformer

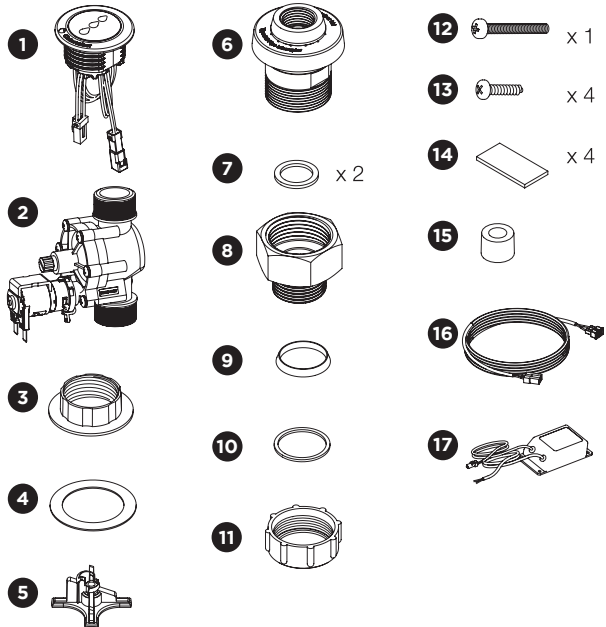

Optional extras

1.5" brass flush pipe fitting (DWC/4)

2. Installation

IMPORTANT: Read this before fitting the WC valve.

Flushing directly from the mains water supply

When flushing WCs or urinals directly from the mains, the Water Regulations require that the water supply be protected by a suitable category 5 protection method or device.

In the case of WCs, this can be achieved in three ways:

- 1 The use of a dedicated supply for flushing use only, supplied from a break tank that protects the mains supply with a type AA, AB or AD air gap.
- 2 The use of a specific type of WC bowl which has been tested and shown to incorporate the equivalent of a type AB air gap.
- 3 The use of a type DC pipe interrupter (supplied with all Cistermiser Direct Flushing products).

A note about type DC pipe interrupters

These devices have an integral air gap; it is therefore important that pipework design and WC bowl selection are appropriate to ensure sufficient flow to flush the WC while preventing water flowing back up and out of the air gap.

The DC pipe interrupter must be installed not less than 300mm above the spill over level of the WC pan.

Ensure you follow these key design and installation points

- Install the valve as high as possible above the WC bowl.
- Install a free-flowing, low restriction connection from the valve to the WC bowl. Ensure the water system can deliver **min. 90 lpm**.
- Use a large pipe size in the pipework between the DC pipe interrupter and the WC.
- The DC pipe interrupter is fitted with a 100 lpm flow regulator to control the flow of water; if you still have issues with the DC pipe interrupter overflowing, it may be necessary to install a further flow restricting device upstream of the valve.

NOTE:

For grey water/rain harvesting. Ensure adequate filtering is fitted, a 10Qm filter is recommended.

NOTE:

As with all water containing products, limescale in hard water areas can affect the products performance. This can result in maintenance to remove the limescale when required. Ensure adequate filtering is fitted, a 10Qm filter is recommended.

NOTE:

For chemical water treatment. If the water system had been treated with chemical dosing, ensure the system is thoroughly flushed before fitting any Cistermiser products. Concentrated chemicals in dead legs can damage the product and result in failure. If the water is treated with Chlorine Dioxide (ClO₂), ensure concentration levels are maintained below 5ppm. Ensure adequate filtering is fitted, a 10Qm filter is recommended.

3. Installation schematic

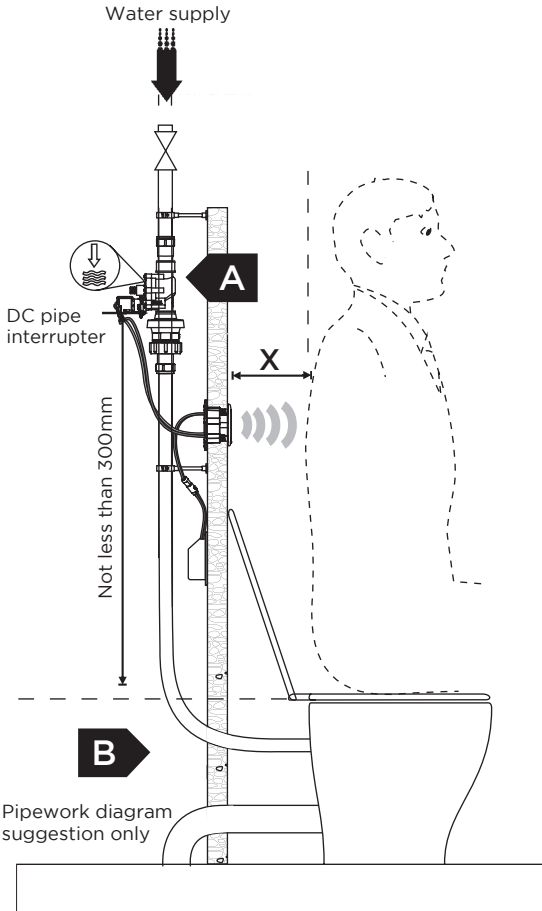

NOTE:

Flush pipework prior to installation. Do not install opposite a mirror. When installed opposite a shiny surface, the range may require adjustment. See section 8 Advanced settings guide.

The valve must be installed at least 300mm above the spill over level to comply with Water Regulations.

When installing the valve it is good practice to ensure there is an accessible isolating valve upstream of the valve.

Ensure flow rate at valve **A** does not exceed the flow rate to the WC bowl **B** to prevent water backing-up to the DC pipe interrupter.

A 1.5m extension cable is supplied if required for placement of sensor.

X - Walkaway version only

If this distance is less than 12cm it is recommended that the Hand Activation is disabled. Refer to Section 9. (ICU required; not supplied).

DMA55 - Mains transformer included with Easyflush Direct (Requires 1A fused spur)

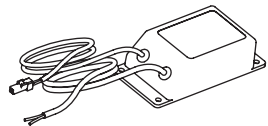

Panel mounted sensor

WAVE only

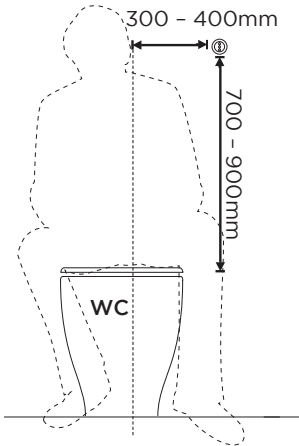

WALKAWAY only

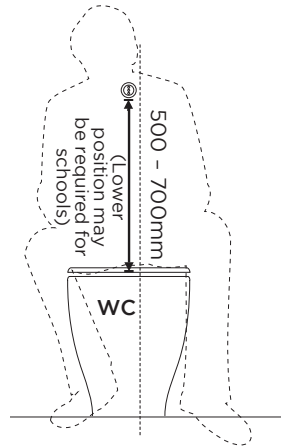

NOTE:

Sensor should be located outside body shape for **WAVE** only.

NOTE:

Sensor should be located inside body shape for **WALKAWAY** only.

Thin wall

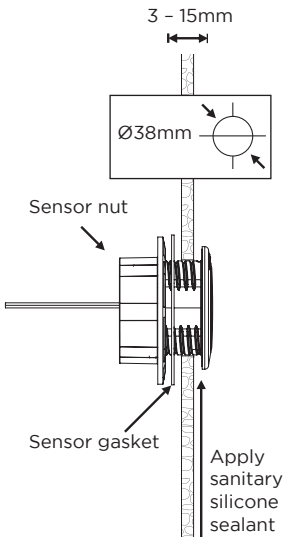

Medium thickness wall

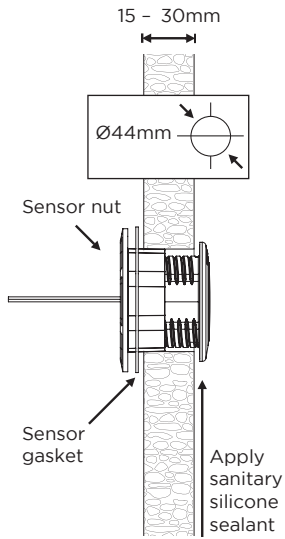

Thick wall

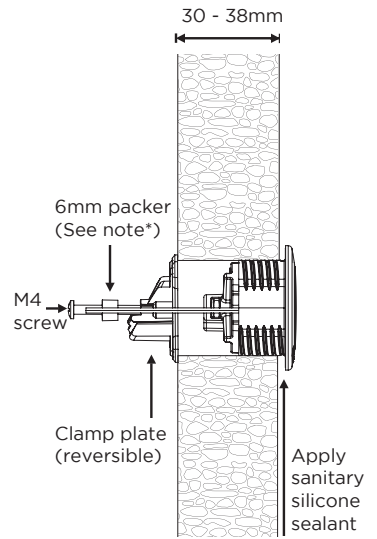

NOTE:

*If wall thickness is under 32mm use packer to prevent screw causing damage to sensor

Easyflush Direct is supplied with a DC pipe interrupter. Fit the DC pipe interrupter to the valve outlet ensuring the rubber seal is in place.

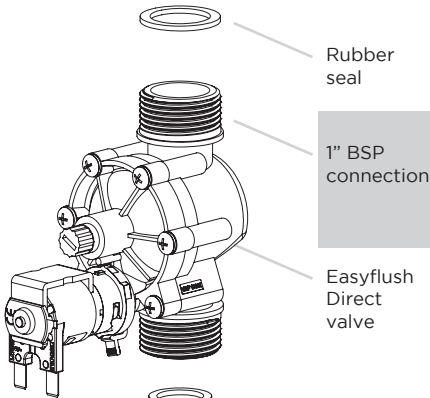

Rubber seal

1" BSP connection

Easyflush Direct valve

NOTE:

To connect to supply pipework you will require a 1" female BSP to 22mm or 28mm (copper) connection (not supplied).

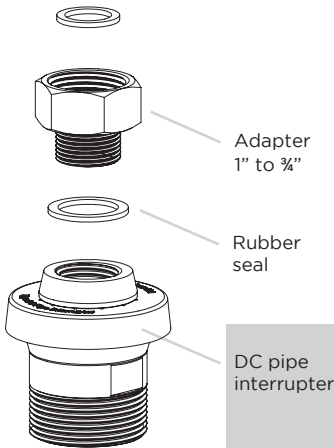

Adapter 1" to 3/4"

Rubber seal

DC pipe interrupter

If the DC pipe interrupter is not required (see 'Flushing directly from the mains water supply' in Section 2), fit a 1.5" flush pipe fitting to the pipe outlet in place of the DC pipe interrupter. Available as a spare part from Cistermiser - DWC/4

NOTE:

Removing the DC pipe interrupter may contravene the Water Regulations. (see page 3)

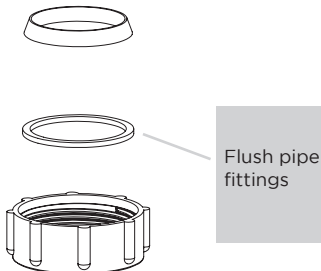

Flush pipe fittings

NOTE:

If you wish to connect to a 2" flush pipe, an adapter can be purchased from your local plumbing merchant.

4. Power Connections

Fasten the mains transformer into place on the panel in a dry location using the screws or adhesive pads provided and connect the un-terminated mains cable to a 50Hz 230V AC single phase supply via a 1A fused spur (not supplied).

Connect the spade connectors from the sensor to the solenoid terminals; take care to connect the wires according to the colour coding on the label. If the wires are not long enough they can be extended by up to 1.5 metres with the cable supplied.

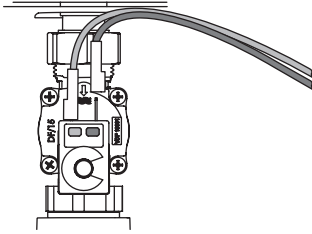

DMA55 mains transformer included with Easyflush Direct (Requires 1A fused spur)

A photograph of a rectangular mains transformer with a power cord and a cable with a connector.

Electrical connection

Connect the power connector from the sensor to the mains transformer.

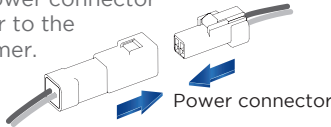

NOTE:

Remove the label from the sensor BEFORE connecting to the power. When the power is first connected the LED in the sensor flashes amber. This is normal and lasts only a few seconds.

Alternative power options

For multiple connections the **Multi-Product Power Supply Unit (PSUC)** can be used to power up to 20 units (not supplied).

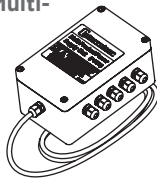

NOTE:

When using a Multi-Product Power Supply Unit (PSUC), ensure polarity is correct.

Brown wire = positive

Grey wire = negative

Additional configuration options

With the **Infrared Configuration Unit (ICU)** remote control (sold separately).

- Hygiene rinse on/off. The installer is able to switch the 12 hr hygiene rinse function on or off.
- Clean mode. The Easyflush Direct can be disabled for a short period to allow for cleaning.
- Toggle wave feature on/off.

5. Configuration

IMPORTANT: Water Flow Rate Requirement

To achieve an effective and efficient flush, the water system needs to deliver at least 90 lpm. Typically this would require that the dynamic/working water pressure, measured before the valve, is at least 2 bar.

To comply with the water regulations the full flush volume must not exceed 6 litres.

The Easyflush Direct is fitted with a 100 lpm flow regulator* that will limit the flow through the valve to 100 lpm.

The flush duration is set by default to 3.5 seconds, this ensures the flush volume will be below 6 litres. The part flush will automatically be set to 0.6 x the full flush duration. This will ensure the part flush volume is less than 2/3rd the full flush volume as specified in the Water Regulations.

To adjust the flush duration and therefore the flush volume see Section 8 'Advanced settings guide'.

The flow rate can also be reduced by turning the adjuster screw in the middle of the valve (clockwise to reduce flow) or by fitting a third party pressure reducing valve above the Easyflush Direct.

Ensure that the dynamic water pressure (pressure measured while the valve is open and water is flowing) is sufficient to achieve the required flow rate.

**Alternative flow regulators are available. Please contact Cistermiser.*

WARNING:



The use of several other appliances from the same water supply simultaneously may reduce the flow rate below 90 lpm.

NOTE:

On smaller pipe sizes please pay particular attention that you achieve 90 lpm at the valve outlet for an effective flush.

Sensor LED Glossary

Sensor Uncalibrated -

1 **red** LED flash 4 times per second



Full Flush via Wave or Walkaway -

2 **green** LEDs flash once per second



Solenoid Failure

(Call Cistermiser for advice) -
2 **red** LEDs flash once per second



Partial Flush via Wave or Walkaway -

1 **green** LED flash once per second



Vandal Fault -

3 **red** LEDs flash once per second



Body Seen -

1 **green** LED flash once every 3 seconds



Low Battery Fault -

1 **red** LED flash once per second



Cleaning Mode -

3 **green** LEDs flash once every half second



* **Amber** LED = Configuration

6. Usage advice and specification

Minimum working pressure:	An effective and efficient flush is achieved with a flow rate of >90 lpm. A typical installation will require 2 bar dynamic pressure, measured before the Easyflush Direct, to achieve 90 lpm.
Maximum pressure:	5 bar

NOTE:

When using the Easyflush Direct valve from a mains water supply, the flow rate may be higher than is suitable for the design of the bowl which can cause splashing to occur. In such cases fit a flow regulator (supplied) as indicated in Section 5.

Back siphonage protection:	Class 5, Type DC
Cleaning:	Clean with soap and water only
Lens care:	Infrared lens can be polished with a soft cloth
Power requirements:	6V DC regulated from mains transformer (1A fused spur required)

Default settings

Wave range (hand):	-10cm
Walkaway range (body)	-50cm
Full flush duration:	3.5 seconds
Part flush duration:	2 seconds

Electronic specification for Mains transformer DMA55

Control classification:	Independent
Output:	6V=0.33A (2W)
Rated temperature range:	0-40°C
Ingress protection:	IP65
Input:	100-250V AC 50/60Hz 1A MAX

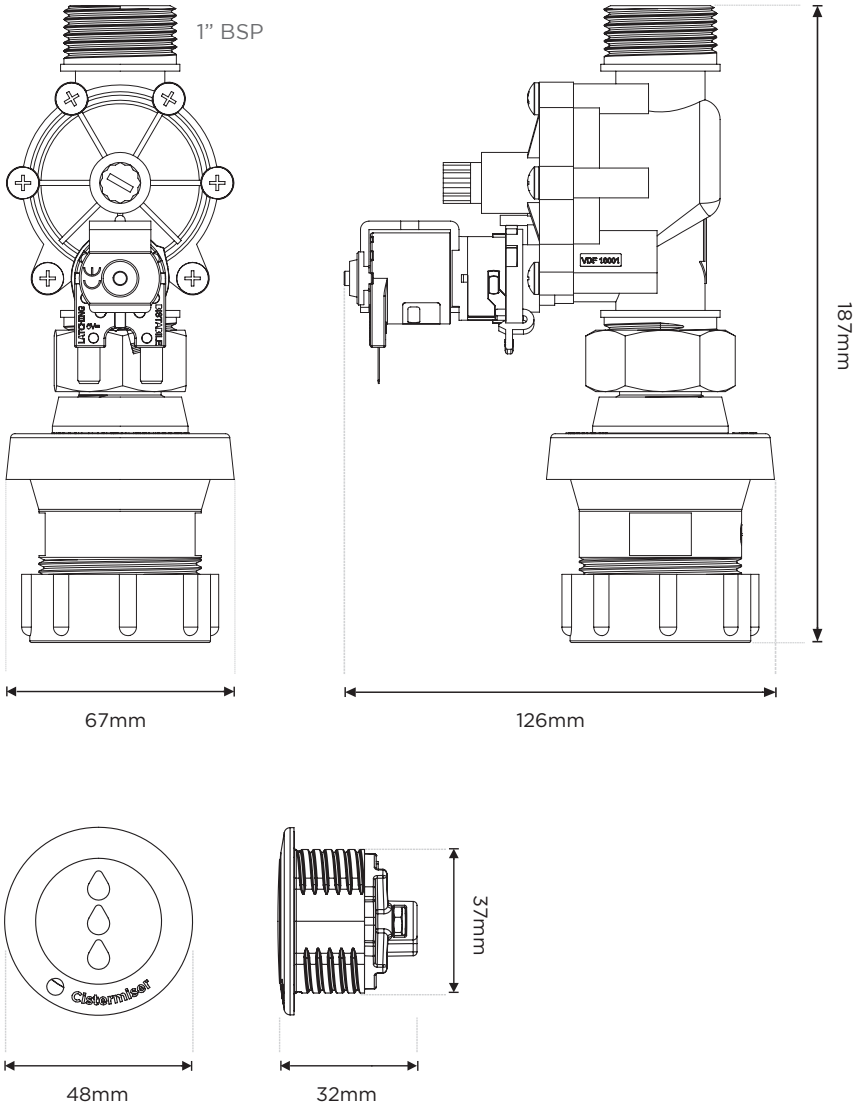

7. Component dimensions



8. Advanced settings guide

Carry out only if default settings need to be changed.

1 Disconnect power, wait for 5 seconds and reconnect.

2 When flashing **amber**.  Place hand 4-6cm from sensor until triple **green** LEDs, then remove hand. 

You are now in configuration mode

3 If a hand is not placed over the sensor, it will go into normal operation mode.

Wave/walkaway mode switching (this will restore default settings)

A Wait for 1 x triple **red** LEDs to enter wave/walkaway setting.  X1

B During the triple **red** flashing, briefly place your hand in front of the sensor. 

The sensor will flash one central **green** LED to indicate wave function. To change function put your hand in front of the sensor for 3 seconds.

C Sensor will flash single central **green** LED for wave mode. 

or double top/bottom **green** LEDs for walkaway. 

Wave sensing range adjustment (when Wave variant is selected)

A Wait for 2 x triple **red** LEDs to enter sensing range mode.  X2

B Briefly place your hand in front of the sensor until the **green** LED flashes slowly. Range configuration mode will then be ready. 

C Move your hand to the distance from the sensor you would like to set as maximum range. Wait 8 seconds until constant triple **green** LEDs show.

 Sensor distance is now set.

Walkaway sensing range adjustment (when Walkaway variant is selected)

- A** Wait for **2** x triple **red** LEDs to enter sensing range mode.



- B** Briefly place your hand in front of the sensor until the **green** LED flashes slowly. Range configuration mode will then be ready.

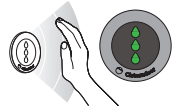

- C** Stand at the distance from the sensor you would like to set as maximum range. Wait 8 seconds until constant triple **green** LEDs show.



Sensor distance is now set.

Full flush duration adjustment

- A** Wait for **3** x triple **red** LEDs to enter flush duration.



- B** During the triple **red** flashing, briefly place your hand in front of the sensor. The valve will start to flush and triple **green** flashing LEDs will be seen. HOLD HAND STEADY.

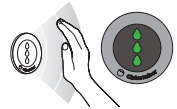

- C** When the valve has flushed for the desired flush time, move your hand out of the line of sight of the sensor and triple **green** LEDs will show. The water will cease to flow and the full flush time will be set.











NOTE:

Part flush duration will be automatically set at 0.6 x full flush duration.

9. Infrared Configuration Unit (ICU)

NOTE: Not supplied but available from Cistermiser or any major plumbing merchant.

Button descriptions

- C** Activates cleaning mode
 -  Activates ICU configuration mode
 - Decreases setting
 - +** Increases setting
 - OK** Checks the setting being altered
 - SAVE** Saves changes and exits ICU configuration mode
 - QUIT** Quits ICU configuration mode without saving changes
- 1**  Configures sensor range
 - 2**  Configures full flush duration
 - 3**  No function
 - 4**  Toggle Wave function ON/OFF (Walkaway ONLY)
 - 5**  12-hour hygiene cycle activation
 - 6**  Dual flush activation
 - 7**  Autorange setting of sensor range
 - 8**  No function
 - 9**  Switch Wave & Walkaway variants/reset to default settings

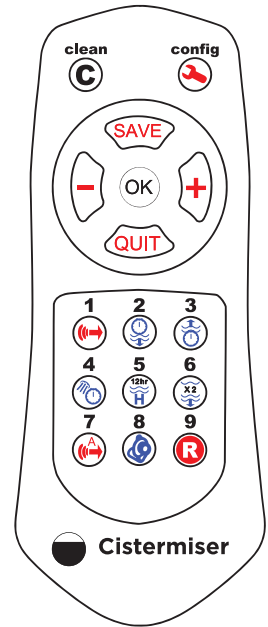



Entering configuration mode

Point the ICU towards the Easyflush Direct sensor and push the  **configuration** button. Activation is most effective when the configuration button is held down as the ICU is brought close to the sensor.

Sensor blinks red when ICU is detected. It can take up to three seconds for the product to sense the ICU. The Easyflush Direct will return to normal operation if there are no button presses for 30 seconds.

Configuring sensor range

Point the ICU at the Easyflush Direct sensor and press the **1**  **sensor range** button (the sensor blinks **green**).

Decrease or increase the sensor range by pressing the  and  buttons respectively.

The sensor blinks red when the min or max value is reached.

Press the  button to check the sensor range setting - the sensor displays the current setting by flashing **green**, as indicated in the table.



Sensing Distance					
Number of flashes	1	2	3	4	5
Distance	Min				Max

Save setting and exit the ICU configuration mode by pressing the **SAVE** button.

Exit without saving by pressing the **QUIT** button.

Configuring the full flush duration

Point the ICU at the Easyflush Direct sensor and press the **2**  **flush duration** button (the sensor blinks **green**).

Decrease or increase the full flush duration by pressing the  and  respectively. The sensor blinks **red** when the min or max value is reached.

Press the  button to check the full flush duration setting - the sensor displays the current setting by flashing **green**; see table.

Number of flashes	1	2	3
Full flush time (sec)	2	3	4

Part flush duration will be automatically set at 0.6 x full flush duration.

Save setting and exit the ICU configuration mode by pressing the  button.

Exit without saving by pressing the  button.

Activating and de-activating the hand wave flushing (Walkaway version only)

Point the ICU at the Easyflush Direct sensor and press the **4**  button (the sensor blinks **green**). By default the hand wave function is on.

Pressing the  and  buttons switches the hand wave function on or off respectively.

Press the  button to check the setting - the sensor flashes **green** once if the function is off or twice if it is on.

Save setting and exit the ICU configuration mode by pressing the  button.

Exit without saving by pressing the  button.

Activating the 12 hour hygiene flush cycle

Point the ICU at the Easyflush Direct sensor and press the **5**  **hygiene cycle** button (the sensor blinks **green**).

Pressing the  and  buttons switches the hygiene flush function on or off respectively.

Press the  button to check the setting - the sensor flashes **green** once if the function is off or twice if it is on.

Save setting and exit the ICU configuration mode by pressing the  button.

Exit without saving by pressing the  button.

Activating the dual flush function

Point the ICU at the Easyflush Direct sensor and press the **6**  **dual flush** button (the sensor blinks **green**).

Pressing the  and  buttons switches the dual flush function on or off respectively.

Press the button  to check the setting - the sensor flashes **green** once if the function is off or twice if it is on.

Save setting and exit the ICU configuration mode by pressing the  button.

Exit without saving by pressing the  button.

Configuring sensor range using the autorange function

If the cubicle door is opposite the sensor, ensure that the cubicle door is closed or ajar, but not fully open.

Point the ICU at the Easyflush Direct sensor and press the **7**  button.



Immediately stand clear of the sensor. Sensor blinks **green** for 5 seconds, then a steady **green** when setting complete. The sensor measures the background reflections and sets the sensor range to an appropriate setting.

Save setting and exit the ICU configuration mode by pressing the  button.

Exit without saving by pressing the  button.

Switch Wave & Walkaway variants

Point the ICU at the sensor and press the **9**  button (the sensor blinks **green**).

Pressing the  and  button switches the function to Wave and Walkaway respectively. Press the OK button to check the setting - the sensor flashes **green** once if wave or twice if walkaway.

Save setting and exit ICU configuration by pressing the  button.

Exit without saving by pressing the  button.

10. Frequently asked questions

Indicators for normal sensor function after user activation

Wave:

- A single green droplet will flash when a part flush is activated.
- A double green droplet will flash when a full flush is activated.

Walkaway:

- The top droplet will flash green when a user is detected.
- A single green droplet will flash when a part flush is activated.
- A double green droplet will flash when a full flush is activated.

No water is entering the bowl

No obvious indicator	Ensure that the water supply is reaching the valve.
	Blockage. Ensure the filter on the inlet of the valve is clear.
	Ensure water pressure >0.5 bar <5 bar for valve to operate. Typically 2 bar for effective flush.
The sensor is obscured	This occurs when an object/debris blocks or covers the sensor, the object/debris needs to be removed from the sensor and Easyflush Direct will resume normal functionality.

The valve is not working at all

The sensor light does not flash when a hand is placed in front of it	Ensure the power supply is connected and wired correctly.
The top droplet will slowly flash red or not at all when a hand is placed in front of it	Low or no power. Ensure spur is live and 6v DC from DMA55 power transformer. Check connection for damp.
No obvious indicator	Ensure water pressure >0.5 bar <5 bar for valve to operate. Typically 2 bar for effective flush.

Continuous flow into the WC bowl from the valve

No obvious indicator	Ensure water pressure is min 0.5 bar. Flush any potential debris out of the valve.
The top droplet will slowly flash red	Low or no power. Contact Cistermiser.

WC flushes when in use

Working as normal otherwise	Ensure that the sensor is mounted in the correct position. Refer to the Sensor positioning (section 3).
	Ensure the sensor range is correctly configured. Refer to the advanced setting guide (Section 8) or Infrared Configuration Unit (ICU) guide.

Flush is ineffective

Working as normal otherwise	Ensure the flow rate of the water supply is 90 lpm.
Blockage	Ensure the filter on the inlet of the valve is clear.

Other issues

The middle droplet flashes red 4x times per second	Sensor uncalibrated. Call Cistermiser for advice.
The top droplet will flash red	Low or no battery power. Change batteries. If mains power operated, check wiring before contacting Cistermiser.
The triple droplets will flash red	Sensor covered or heavily scratched. Uncover or polish out scratches.

Cistermiser product warranty and extended warranty

Cistermiser products are guaranteed for 12 months from the date of manufacture. The guarantee is for faulty products and parts only: there is no labour warranty. If you believe your product is faulty, please either contact Cistermiser directly on **0118 969 1611** or at **support@cistermiser.co.uk**, with a photograph and the serial number, to help diagnose the cause of the problem.

The warranty on Cistermiser products can be extended, at no cost within one year of date of manufacture, to three years from the date of installation by completing the enclosed warranty card or at **www.cistermiser.co.uk/warranty**. Please make a note of the serial number and take a photograph of the installation before you leave site.

Commissioning check-list

Easyflush Direct

Cistermiser products are guaranteed for 12 months from the date of manufacture.

3 YEAR extended warranty	The warranty on Cistermiser products can be extended within one year of date of manufacture, at no cost, to three years from the date of installation by completing online registration at www.cistermiser.co.uk/product-registration and completing and returning the commissioning checklist below.
---------------------------------------	-----------------------------------------------------------------------------------------------------------------------------------------------------------------------------------------------------------------------------------------------------------------------------------------------------------------------------------------------------------------------

Product serial number

Installation address

No	Activity	Checked	Date
1.	Flush pipework prior to installation.	<input type="checkbox"/>	<input type="checkbox"/>
2.	Check valve orientation: valve should normally be mounted more than 150mm from spill over level of toilet pan.	<input type="checkbox"/>	<input type="checkbox"/>
3.	Install an isolation valve upstream of solenoid valve.	<input type="checkbox"/>	<input type="checkbox"/>
4.	Check all connections for leaks.	<input type="checkbox"/>	<input type="checkbox"/>
5.	Ensure water supply pressure is above 2 bar dynamic, to give a minimum of 90 litres per minute at valve entry.	<input type="checkbox"/>	<input type="checkbox"/>
6.	Check sensor is mounted in correct position for type of sensor. (See installation instructions)	<input type="checkbox"/>	<input type="checkbox"/>
7.	Ensure label is removed from sensor before connecting power.	<input type="checkbox"/>	<input type="checkbox"/>
8.	Check electrical connections: To the solenoid orange to orange, blue to blue. Ensure either mains or battery power or multi product power supply is connected.	<input type="checkbox"/>	<input type="checkbox"/>
9.	Check operation: adjust sensor range and flush time if necessary.	<input type="checkbox"/>	<input type="checkbox"/>
10.	Test operation.		
a	Wave: Place hand within 10 cm of sensor for 1 second valve will part flush; sensor will flash once per second. Place hand within 10cm of sensor for 2 seconds valve will full flush, sensor will flash twice per second.	<input type="checkbox"/>	<input type="checkbox"/>
b	Walkaway: If presence is detected sensor flashes green once every 3 seconds. Sensor detects a presence for less than 40 seconds, valve will part flush. Sensor detects a presence for over 40 seconds valve will full flush.	<input type="checkbox"/>	<input type="checkbox"/>

Cistermiser Limited

Unit 1, Woodley Park Estate, 59-69 Reading Road,
Woodley, Reading, Berkshire RG5 3AN

t: +44 (0) 118 969 1611

e: sales@cistermiser.co.uk

cistermiser.co.uk

Part of Genuit Group plc



Cistermiser only use papers from sustainable sources