

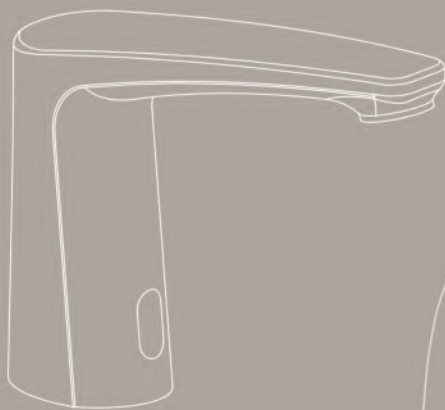

Cistermiser
OUR WORLD IS WATER

Infrared Taps Installation Guide



1. Introduction

Cistermiser's infrared taps are available with either an internal or external valve.

The taps all use infrared technology which ensures maximum hygiene and water efficiency.

All taps are supplied configured with the 5 litres per minute aerators installed but also include a 3.5 litres per minute laminar nozzle. The taps have a programmable hygiene cycle to reduce the risk of legionella.

Supplied parts

Internal valve

1. Spout body
2. Flexible hose
3. Spout gasket
4. Bracket gasket
5. Fixing bracket
6. Screw **A** x 4
7. Washer x 2
8. Fixing nut x 2
9. Mains adapter*
10. Battery case*
11. Sticky pad x 4
12. Filter
13. 3.5 litre nozzle (blue)*
14. Nozzle tool

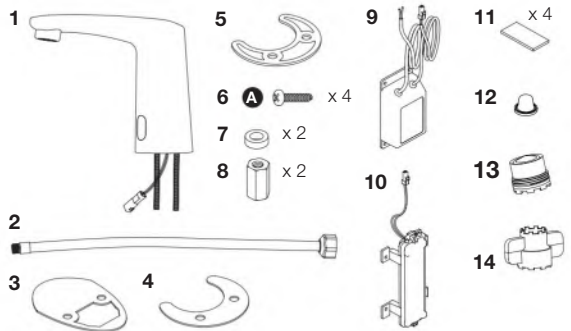

External valve

1. Tap body
2. Flexible hose
3. Spout gasket
4. Bracket gasket
5. Fixing bracket
6. Screw **A** x 4
7. Fixing nut x 2
8. Mains adapter*
9. Battery case*
10. Sticky pad
11. Solenoid valve
12. 3.5 litre nozzle (blue)*
13. Nozzle tool
14. Extension cable – solenoid cable 0.5m

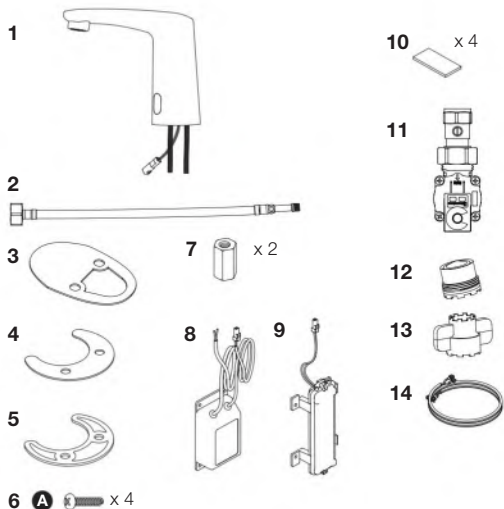

Optional extras (Suitable for all Cistermiser IR Range products):

Infrared configuration unit (ICU)

Multi product power supply unit (PSUC)

*LT versions include one power option + one flow regulator

2. Installation of internal valve tap

NOTE:

Flush pipework prior to installation.
Do not install opposite a mirror.
Minimum 0.5 Bar dynamic pressure.

The tap can be mounted on any horizontal surface up to 40mm thick. It requires a hole of 32.5-36mm diameter.

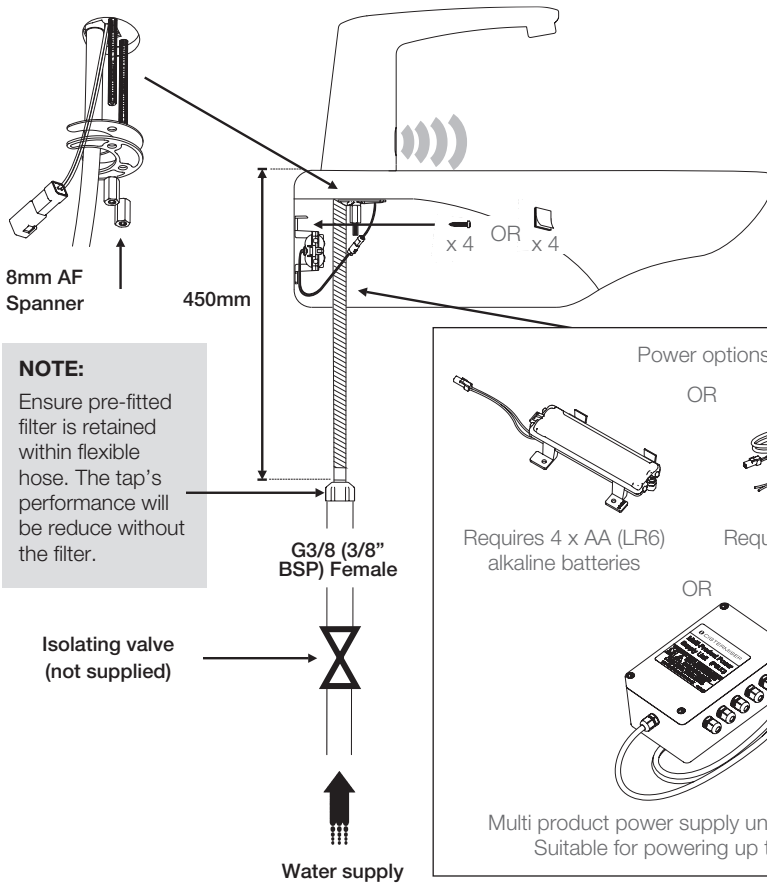

NOTE:

Ensure pre-fitted filter is retained within flexible hose. The tap's performance will be reduced without the filter.

NOTE:

When installing the inlet pipework, it is good plumbing practice to ensure that there is an accessible isolating valve upstream of the tap.

How to change the nozzle

Use the nozzle tool to unscrew the 5 litre (orange) nozzle. Insert the 3.5 litre (blue) nozzle and tighten until flush with tap body; no part should be protruding from the end of the tap. Ensure the nozzle is not over-tightened as this may pinch the "O" ring and cause the tap to leak.

Installation of external valve tap

NOTE:

Flush pipework prior to installation.
Do not install opposite a mirror.
Minimum 0.5 Bar dynamic pressure.

The tap can be mounted on any horizontal surface up to 40mm thick. It requires a hole of 32.5-36mm diameter.

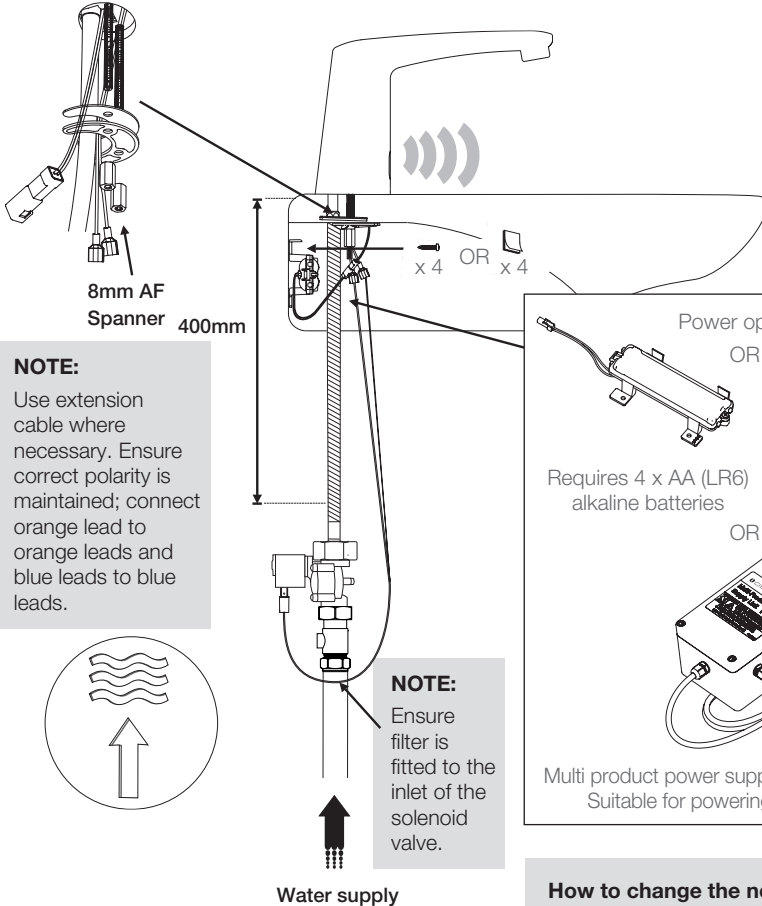

NOTE:

Use extension cable where necessary. Ensure correct polarity is maintained; connect orange lead to orange leads and blue leads to blue leads.

NOTE:

Ensure filter is fitted to the inlet of the solenoid valve.

Power options

OR

Requires 4 x AA (LR6) alkaline batteries

Requires 1A fused spur

OR

Multi product power supply unit (not supplied). Suitable for powering up to 20 units.

How to change the nozzle

Use the nozzle tool to unscrew the 5 litre (blue) nozzle. Insert the 3.5 litre (blue) nozzle and tighten until flush with tap body; no part should be protruding from the end of the tap. Ensure the nozzle is not over-tightened as this may pinch the "O" ring and cause the tap to leak.

3. Power connections

NOTE:

Only one power source should be connected at any time, either mains or batteries. It is not possible to connect both simultaneously.

If using the battery case, open it and fit 4 Alkaline AA (LR-6) batteries as indicated. Reseal and fasten into place on panel using screws **A** or with the sticky pads.

If using the mains adapter, fasten into place on panel in a dry location using screws **A** or with the sticky pads and connect the un-terminated mains cable to a 50Hz 230V AC single phase supply via a 1A fused spur (not supplied).

Electrical connection

Connect the power connector from the tap to the mains adapter, or in the case of a battery powered installation, the battery case.

4. Usage advice and specification

Minimum operating pressure:	0.5 bar (dynamic)
Maximum operating pressure:	6 bar (dynamic or static – whichever is highest)

Factory settings

Range:	~18cm
Run-on time:	2 sec
Power requirements:	Either 6VDC from 4 x alkaline AA (LR6) batteries or 6VDC regulated from mains adapter. (1A fused spur required)
Battery life:	2 years in normal conditions with recommended batteries. A single red flashing of the LED indicates that the batteries are low and need to be replaced.
Cleaning:	Clean with non-abrasive cleaner and water only.
Lens care:	Infrared lens can be polished with a soft cloth.

Electronic specification

Control classification:	Independent
Maximum load:	Internal valve models: 1.2W 0.2A (6VDC) External valve models: 2W 0.33A (6VDC)
EMC emissions:	Tested at above load
Rated temperature range:	0-40° C
Action classification:	Type 1.Y
Pollution classification:	Degree 1

5. Component dimensions

Novatap

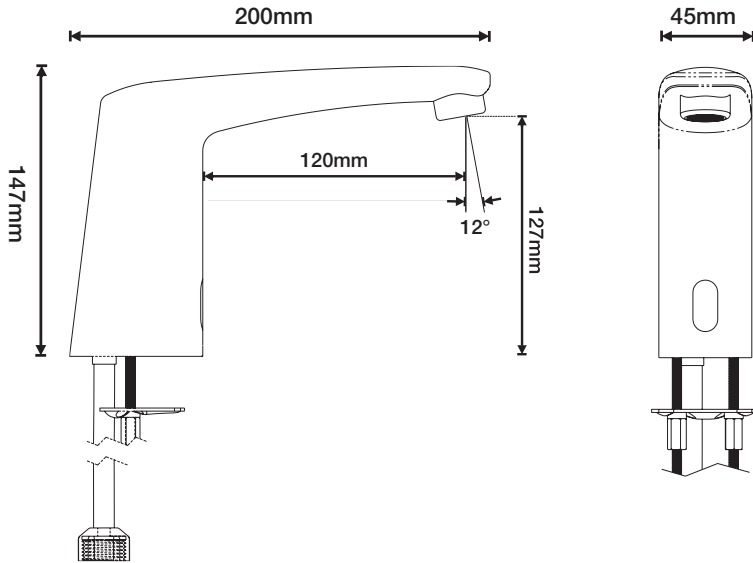

Vectatap

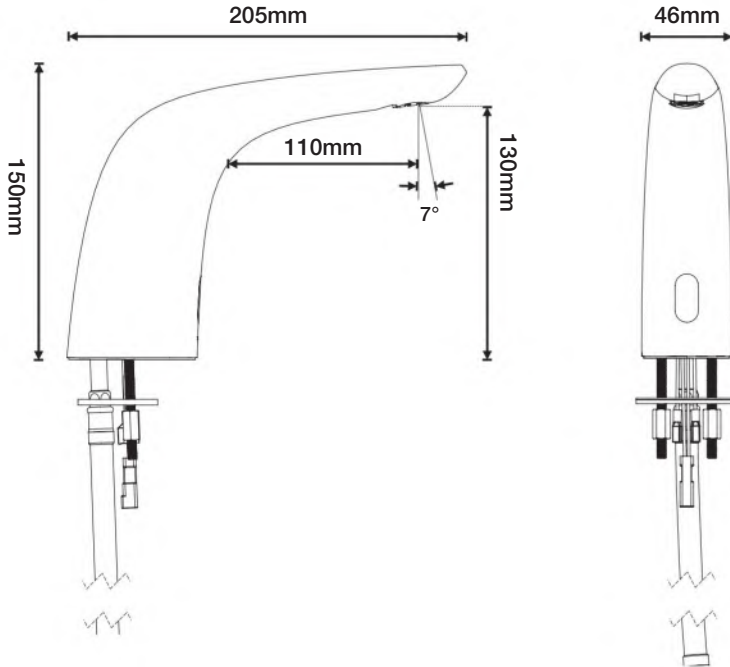

Flow rate chart

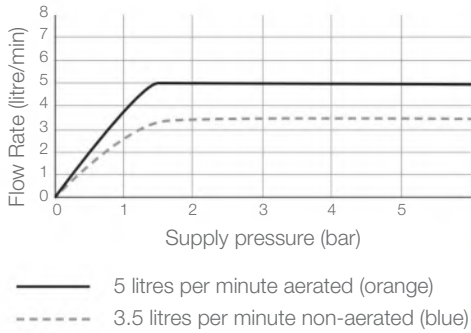



NOTE:
Valve may fail to operate at under 0.5 bar dynamic pressure.

6. Advanced settings guide

Carry out only if settings need to be changed





1 Disconnect power, wait for 5 seconds and reconnect.

2 When **flashing amber**  Place hand 4-6cm from sensor until **constant green**. Then remove hand.  



3 You are now in configuration mode

If a hand is not placed over the sensor, it will go into normal operation mode.

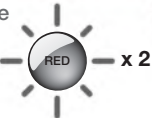

Sensing range adjustment

- A Wait for **single red flashing LED** to enter sensing range mode 
- B Briefly place your hand in front of the sensor until the **green LED flashes slowly**. Range configuration mode will then be ready  
- C Move your hand to the distance from the sensor you would like to set as maximum range. Wait 8 seconds until **constant green** shows  Sensor distance is now set

Run-on time adjustment

- A Wait for **double red flashing LED** to enter run-on time  x 2
- B During **double red flashing** briefly place your hand in front of the sensor, water will start running while a **green flashing** will be seen. **HOLD HAND STEADY**  
- C When the water has run for the desired run-on time, move your hand out of the line of sight of the sensor. The water will cease and the run-on time will be set.

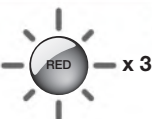
12hr hygiene rinse cycle activation

- A Wait for **triple red flashing LED** to enter hygiene rinse activation  x 3
- B During **triple red flashing** place your hand in front of the sensor. Single green flash = on. Double green flash = off. To change state briefly move your hand away and replace in front of the sensor again.  
- C When the water has run for the desired run-on time, move your hand out of the line of sight of the sensor. The water will cease and the run-on time will be set.



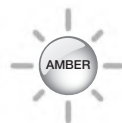







4 After configuration the unit will **flash amber** giving opportunity to re-enter configuration mode



7. Infrared Configuration Unit (ICU) guide

NOTE: Not supplied but available from Cistermiser or any major plumbing merchant.

Button descriptions

-  Activates cleaning mode
-  Activates ICU configuration mode
-  Decreases setting
-  Increases setting
-  Checks the setting being altered
-  Saves changes and exits ICU configuration mode
-  Quits ICU configuration mode without saving changes
- 1**  Configures sensor range
- 4**  Configures run-on time
- 5**  12 hour hygiene cycle activation
- 9**  Resets to default factory settings

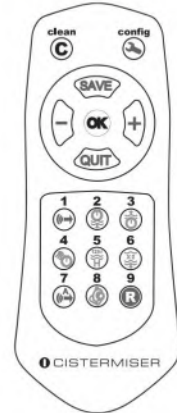

Inserting and replacing batteries

The ICU uses 2 AAA or LR03 alkaline batteries, these must be installed before use. Always use new batteries of the same type. Install as indicated in the battery compartment on the rear of the ICU.

NOTE: Batteries should be replaced when the signal of the ICU becomes weak and it becomes difficult to activate either cleaning or configuration mode.

Activating cleaning mode

Cleaning mode, disables normal operation for cleaning for a timed 30 seconds. In order to activate cleaning mode with the ICU, it must be pointed at the sensor of the selected washroom product. Activation is most effective when the  clean button is held down as the ICU is brought close to the sensor. It can take up to 3 seconds for the product to sense the ICU.

When the washroom product is in Clean Mode, the sensor flashes green once a second.

Activating ICU configuration mode

In order to activate ICU configuration mode with the ICU, it must be pointed at the sensor of the selected washroom product. Activation is most effective when the  configuration button is held down as the ICU is brought close to the sensor. It can take up to 3 seconds for the product to sense the ICU.

The washroom product will return to normal operation if there are no button presses for 30 seconds.

Infrared taps

The ICU can adjust/activate the sensor range, the run-on time and the 12hr hygiene cycle settings.

The product must always be put into ICU configuration mode before any setting can be configured.

Configuring sensor range

Point the ICU at the sensor and press the **1** (H) sensor range button (the sensor blinks green).

Decrease or increase the sensor range by pressing the **←** and **→** buttons respectively. The sensor blinks red when the min or max value is reached.

Press the **OK** button to check the sensor range setting – the sensor displays the current setting by flashing green, see table.

Number of flashes	1	2	3	4	5
Range (cm approx)	8	11	14	16	18

Save setting and exit ICU configuration mode by pressing the **SAVE** button.

Exit without saving by pressing the **QUIT** button.

Configuring run-on time

Point the ICU at the sensor and press the **4** (R) run-on time button (the sensor blinks green).

Decrease or increase the run-on time by pressing the **←** and **→** buttons respectively. The sensor blinks red when the min or max value is reached.

Press the **OK** button to check the run-on time setting – the sensor displays the current setting by flashing green, see table.

Number of flashes	1	2	3	4	5	6	7	8
Run-on time (sec)	1	2	3	4	5	10	20	30

Save setting and exit ICU configuration code by pressing the **SAVE** button.

Exit without saving by pressing the **QUIT** button.

Configuring the 12hr hygiene rinse cycle

Point the ICU at the sensor and press the **5** (R) 12hr hygiene rinse button (the sensor blinks green).

Decrease or increase the hygiene rinse time by pressing the **←** and **→** buttons respectively. The sensor blinks red when the min or max value is reached.

Press the **OK** button to check the hygiene rinse time setting – the sensor displays the current setting by flashing green, see table.

Number of flashes	1	2	3	4	5	6
Hygiene rinse time (sec)	0	5	10	15	30	60

Save setting and exit ICU configuration mode by pressing the **SAVE** button.

Exit without saving by pressing the **QUIT** button.

Reset to factory settings

Point the ICU at the sensor and press the **9** (R) reset button (the sensor blinks green). This sets all settings to the default factory settings.

Save setting and exit ICU configuration mode by pressing the **SAVE** button.

Exit without saving by pressing the **QUIT** button.

8. Frequently asked questions

No water from tap

The sensor is flashing red once a second	Low battery. Change batteries.
The sensor is not flashing at all when hands are in sensing range	No power. Change batteries if battery powered. Ensure power is switched on and is reaching the tap. Check all electrical connections.
The sensor is flashing green once a second when hands are in sensing range but there is no water	Water supply. Ensure water supply has been turned on and there is good working pressure. Minimum dynamic pressure 0.5 bar. Filter blockage Internal valve Check filter in flexible hose External valve Check filter in inlet to solenoid valve
The sensor is covered	Anti-vandal mode has been triggered. The object/debris needs to be removed and the tap will resume normal functionality.

Continuous flow of water or dripping from the tap

The sensor is not flashing at all when hands are in sensing range	No power. The power has failed whilst the solenoid valve is open. Change batteries if battery powered. Ensure power is switched on and is reaching the tap check all electrical connections.
Water is flowing when no user is present	Water supply. Ensure water pressure is not above maximum dynamic pressure of 6 bar or below minimum dynamic pressure of 0.5 bar. Internal valve Debris or scale in diaphragm/solenoid. Contact Cistermiser Technical Department. External valve Ensure the arrow on the valve is pointing in the direction of water flow. Debris or scale in the diaphragm: isolate water supply to the valve and remove wires attached to the solenoid. Undo the 4x screws and remove. This will give you access to the diaphragm (note orientation of diaphragm when reinstalling), flush under cold water and visually inspect. Re-install. Diaphragm has been damaged by debris. Carry out procedure for 'Debris or scale in diaphragm', visually inspect then call Cistermiser for further instructions.

Water flow diminishes

The sensor is flashing green once a second when hands are in sensing range	Filter or aerator is blocked with scale or debris. Remove aerator tap using key supplied, clean and reinstall. Check filters prior to the aerator at the TMV. For internal valve taps, check filter within the flexible connector. For external valve taps, check filter in inlet to solenoid.
---	--

8. Frequently asked questions

Water flow as expected and then diminishes immediately

The sensor is flashing green once a second when hands are in sensing range

TMV/water pressure issue. Ensure TMV is operating correctly and water pressures are suitable for TMVs installed.

Water is always cold

The sensor is flashing green once a second when hands are in sensing range

TMV/hot water plumbing issue. Ensure TMV is set up correctly; hot water runs in buildings can sometimes be lengthy. There may be a short delay until hot water is dispensed from the tap.

Other alarms

Double red flash	Faulty wiring. Check wiring. Faulty solenoid. Call Cistermiser for advice.
Red flash once every second	Low battery power. Change batteries.
Red flash twice every three seconds	Sensor covered or heavily scratched. Uncover sensor or polish out scratches.

Cistermiser product warranty and extended warranty

Cistermiser products are guaranteed for 12 months from the date of manufacture. The guarantee is for faulty products and parts only: there is no labour warranty. If you believe your product is faulty, please either contact Cistermiser directly on **0118 969 1611** or at **support@cistermiser.co.uk**, with a photograph and the serial number, to help diagnose the cause of the problem.

The warranty on Cistermiser products can be extended within one year of date of manufacture, at no cost, to three years from the date of installation. Please make a note of the serial number and take a photograph of the installation before you leave site.

Commissioning check-list

3 YEAR
extended
warranty

The warranty on Cistermiser products can be extended within one year of date of manufacture, at no cost, to three years from the date of installation. Once the valve has been installed, complete the product commissioning checklist below to demonstrate compliance with the installation instructions. Email a photograph of this completed form to warranty@cistermiser.co.uk or post to **Cistermiser, Unit 1, Woodley Park Estate, 59-69 Reading Road, Woodley, Berks, RG5 3AN.**

Product serial number

Installation address

Installer's name

Telephone number

Email address

No.	Activity	Checked	Date
1.	Flush pipework prior to installation.	<input type="checkbox"/>	<input type="checkbox"/>
2.	Ensure filters are fitted to the supplied pipe work (see page 4 & 5 for details).	<input type="checkbox"/>	<input type="checkbox"/>
3.	Ensure water supply working/dynamic pressure is between 0.5 – 6 bar.	<input type="checkbox"/>	<input type="checkbox"/>
4.	Check product flow-rate suitability to application.	<input type="checkbox"/>	<input type="checkbox"/>
5.	Check all connections for leaks; ensure isolation valve is installed before the tap internal valve models.	<input type="checkbox"/>	<input type="checkbox"/>
6.	Check flexible hose is not kinked/twisted.	<input type="checkbox"/>	<input type="checkbox"/>
7.	External taps: check flow direction of solenoid valve.	<input type="checkbox"/>	<input type="checkbox"/>
8.	Check electrical connections: tap to solenoid (external valves), orange to orange, blue to blue. Ensure either mains or battery power or multi product power supply unit is connected.	<input type="checkbox"/>	<input type="checkbox"/>
9.	Check operation, adjust sensor range and run-on time adjustment (see advanced settings guide).	<input type="checkbox"/>	<input type="checkbox"/>

Cistermiser range

Urinal flushing

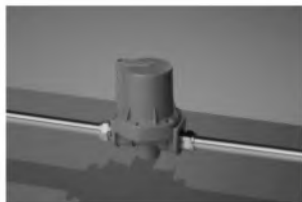

Hydraulic Valve

An automatic urinal flush control valve which reduces water consumption. The valve uses a simple patented mechanism which prevents water waste by ensuring that the auto-flush cistern is only filled, and can only flush, when the washroom is used.



Infrared Control (IRC) Valve

This valve automatically manages the water supply to the urinal cistern and reduces water consumption by up to 80%. The PIR sensor detects movement and activates the solenoid valve, allowing water into a urinal cistern.



Direct Flush Valve

An infrared sensor controlled urinal valve. It automatically flushes individual urinals after use, ensuring the highest level of hygiene from the minimum volume of water.

WC flushing



Easyflush Wave

An infrared, hands-free and water-conserving WC cistern flush valve suitable for concealed or exposed cisterns. Easy to install in retrofits or new installations, its no-touch dual flush WC cistern valve promotes water economy and hygiene in domestic and commercial washrooms.



Easyflush Walkaway

An infrared controlled automatic WC cistern flush valve that is suitable for concealed cisterns. The valve flushes once the user exits the cubicle. Ideal for use in environments where hygiene and water economy are concerns.



Easyflush Direct

An infrared electronic flushing system that removes the need for a WC cistern by taking its water feed straight from the mains supply. Ideal for high traffic areas as the system allows for a second flush without a delay.

Infrared Taps



Novatap

A contemporary deck-mounted chrome tap. The infrared control reduces water and energy usage and eliminates the risk that the tap may be left running.



Vectatap

An elegantly designed infrared tap with the benefit of hygienic hands-free operation. Vectatap improves water and energy efficiency and includes auto-shut off and hygiene flush features.

Washroom control systems



Sensazone

An innovative system to conserve water and energy. Occupancy is monitored by sensors; when someone enters the washroom all services controlled by Sensazone are activated – the hot and cold water, lighting and extractor fans.

Remote Monitoring



LinkThru

LinkThru TMU delivers remote real-time monitoring of water temperatures on a 24/7 basis. LinkThru TMU harnesses the power of the Internet of Things to monitor water temperatures and helps to ensure Building Owner compliance with HSG274, reducing the risk of Legionella.

Davidson Holdings' brands



Salamander is one of the UK's leading manufacturers of pumps for boosting water pressure for showers, bathrooms and whole house supply in domestic and small commercial tank-fed systems.

www.salamanderpumps.co.uk



Talon is the UK market leader in the manufacture and supply of plastic pipe clips, pipe collars and fixing plugs, plus a range of cover profiles for concealing pipework.

www.talon.co.uk



Keraflo manufacture delayed action float valves, which provide an accurate and effective method of controlling the level of stored cold water in tanks both with and without raised float valve chambers. The range is used in domestic, commercial and industrial applications worldwide.

www.keraflo.co.uk



Combimate is a domestic limescale prevention device that prevents limescale build-up and soft water corrosion in combination boilers and other domestic hot water appliances.

www.combimate.co.uk



Homeboost is an intelligent pump from Salamander Pumps that recognises when water flow is less than 12 ltrs/min and automatically boosts the performance of the incoming mains water up to 12 ltrs/min.

www.home-boost.co.uk



Cistermiser Limited

Unit 1, Woodley Park Estate, 59-69 Reading Road,
Woodley, Reading, Berkshire RG5 3AN

t: +44 (0) 118 969 1611

e: sales@cistermiser.co.uk www.cistermiser.co.uk

A Davidson Holdings company