



COMPACT WITH STYLE HORIZONTAL & LO-LINE

The subtle architectural look and feel of the Stelrad Compact with Style is combined with value, range and availability to give you sophisticated designer styling for any room.

	<i>HORIZONTAL</i>	<i>LO-LINE</i>
<i>RANGE</i>	44	8
<i>TYPES</i>	K1, K2	P+, K2
<i>HEIGHTS (MM)</i>	300 - 600	200
<i>LENGTHS (MM)</i>	500 - 2000	500 - 2000
<i>OUTPUTS (WATTS)</i>	235 - 3202	242 - 1228
<i>OUTPUTS (BTU/HR)</i>	802 - 10928	826 - 4191
<i>COLOURS</i>	36	White RAL 9016
<i>WORKING PRESSURE</i>	10 bar	10 bar



All colour radiators have up to an 8 week lead time, and when a coloured radiator or radiators have been ordered they cannot be cancelled or returned.





Horizontal



Horizontal



Lo-line

Compact with Style Horizontal Stelrad® Designer Series



50 Δt

(75/65/20°C)

K1



K2



Height mm	Length mm	Sections	Stelrad UIN	Heat output		Stelrad UIN	Heat output	
				Watts	Btu/hr		Watts	Btu/hr
300	500	15	7431105	235	802	7432205	465	1587
	1000	30	7431110	469	1601	7432210	929	3171
	1400	42	7431114	657	2242	7432214	1301	4440
	2000	60	7431120	938	3201	7432220	1858	6341
500	400	12	7451104	298	1017	7452204	555	1894
	600	18	7451106	448	1529	7452206	833	2843
	800	24	7451108	597	2038	7452208	1110	3788
	1000	30	7451110	746	2546	7452210	1388	4737
	1200	36	7451112	895	3055	7452212	1666	5686
	1400	42	7451114	1044	3563	7452214	1943	6631
	1600	48	7451116	1194	4075	7452216	2221	7580
	1800	54	7451118	1343	4584	7452218	2498	8526
600	400	12	7461104	348	1188	7462204	640	2184
	600	18	7461106	522	1782	7462206	961	3280
	800	24	7461108	696	2375	7462208	1281	4372
	1000	30	7461110	870	2969	7462210	1601	5464
	1200	36	7461112	1044	3563	7462212	1921	6556
	1400	42	7461114	1218	4157	7462214	2241	7649
	1600	48	7461116	1392	4751	7462216	2562	8744
	1800	54	7461118	1566	5345	7462218	2882	9836
	2000	60	7461120	1740	5939	7462220	3202	10928

Δt50 is the UK's industry standard for heating outputs, which has an operating temperature of 75/65/20°C.

If you have a low temperature heat source you may wish to consider Δt40 or Δt30 output (see your installer or system designer or download from www.stelrad.com).

For further assistance on colour option UINs and prices, please contact the sales admin team on 0844 543 6200.

EN 442 CERTIFICATION DATA - CETIAT TESTED IN ACCORDANCE WITH BS EN 442

Type	K1			K2		
	300	500	600	300	500	600
Height	300	500	600	300	500	600
W/m at 75/65/20	470	746	870	898	1388	1601
n-coefficients	1.26	1.28	1.28	1.30	1.31	1.31
Heated surface area (m ² /m)	2.09	3.80	4.66	3.51	6.33	7.74
Weight (kg/m)	14.13	20.23	24.27	19.30	32.03	38.40
Water contents (l/m)	1.81	2.77	3.23	3.10	5.17	6.20
Wall to tap centre (mm)	54	54	54	-	-	-
Floor standing	-	-	-	76	76	76

Compact with Style Horizontal Stelrad® Designer Series



WALL MOUNTING INFORMATION

All dimensions in mm. Inches in brackets. Floor mounting brackets available.

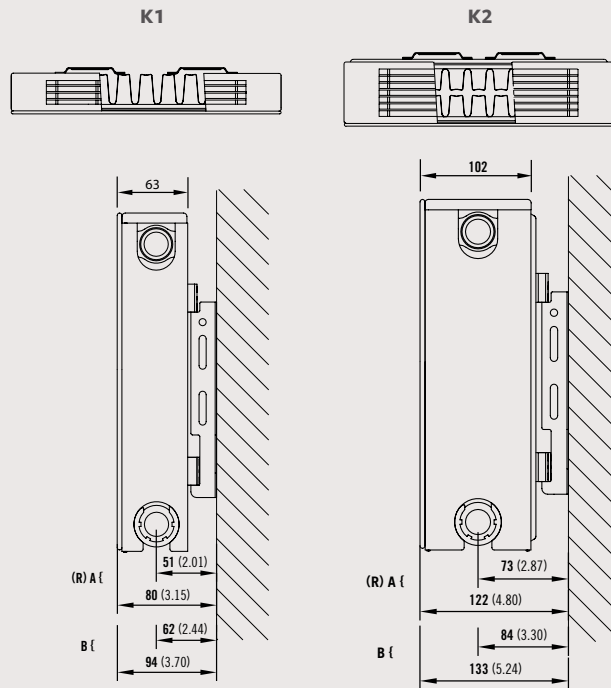

MOUNTING BRACKETS

All dimensions in mm. Inches in brackets. Floor mounting brackets available.

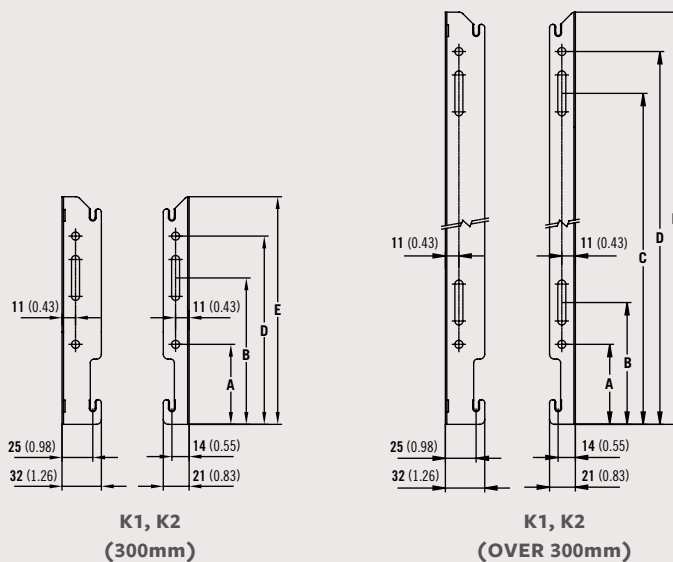

**K1, K2
(300mm)**

**K1, K2
(OVER 300mm)**

Dimensions	mm	inches	mm	inches	mm	inches	mm	inches
Height	300	11.81	450	17.72	600	23.62	700	27.56
A	65	2.56	65	2.56	65	2.56	65	2.56
B	119	4.69	99	3.90	99	3.90	99	3.90
C	-	-	269	10.59	419	16.50	519	20.43
D	153	6.02	303	11.93	453	17.83	553	21.77
E	185	7.28	335	13.19	485	19.09	585	23.03

Compact with Style Horizontal Designer Series



K1 AND K2 LUG POSITIONS (New as of June 2016).
All dimensions in mm. Inches in brackets.

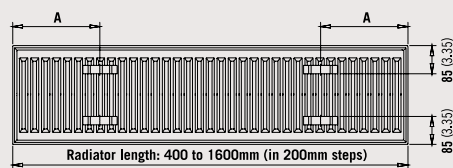
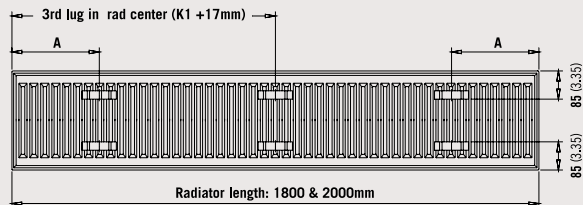

Length	K1		K2	
	mm	mm	mm	mm
400mm	117	4.61	133	5.24
500 - 1000mm	150	5.91	133	5.24
1200 - 1600mm	133	5.24	133	5.24
1800 - 2000mm	3rd lug in rad. centre*			

*K1 + 17mm

CONNECTIONS

Each radiator comes with 1/2" inlet connections as standard.

PRESSURE DROPS

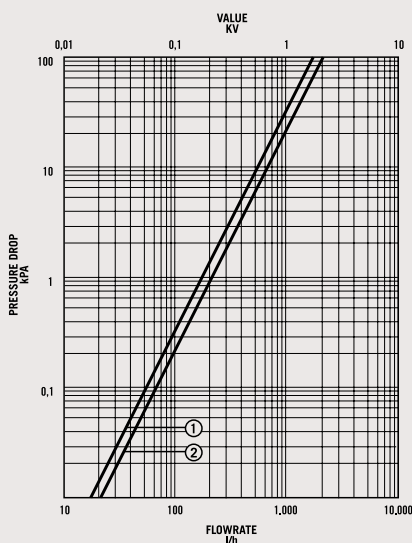

- ① Type 10 (P1), 11 (K1)
- ② Type 21 (P+), 22 (K2)

PIPING OPTIONS

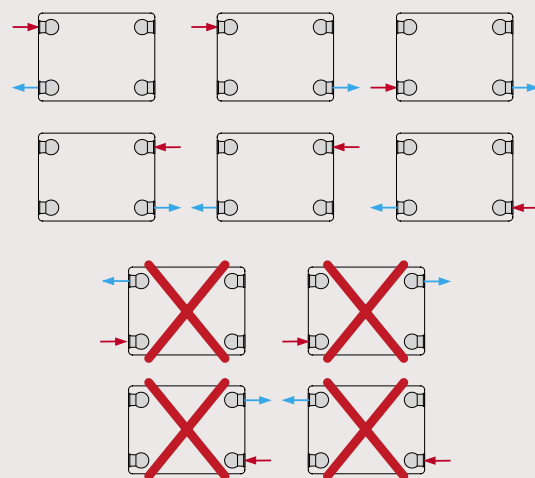

Compact with Style Lo-Line Stelrad® Designer Series

50 Δt

(75/65/20°C)



Height mm	Length mm	Sections	Stelrad UIN	Heat output		Stelrad UIN	Heat output	
				Watts	Btu/hr		Watts	Btu/hr
200	500	15	7422105	242	826	7422205	307	1048
	1000	30	7422110	483	1648	7422210	614	2096
	1400	42	7422114	676	2307	7422214	860	2935
	2000	60	7422120	966	3297	7422220	1228	4191

Δt50 is the UK's industry standard for heating outputs, which has an operating temperature of 75/65/20°C. If you have a low temperature heat source you may wish to consider Δt40 or Δt30 output (see your installer or system designer or download from www.stelrad.com).

EN 442 CERTIFICATION DATA - CETIAT TESTED IN ACCORDANCE WITH BS EN 442

Type	P+	K2
Height	200	200
W/m at 75/65/20	483	614
n-coefficients	1.31	1.29
Heated Surface Area (m ² /m)	1.51	2.10
Weight (kg/m)	12.14	13.15
Water Contents (l/m)	2.64	2.70

FLOOR MOUNTING INFORMATION

All dimensions in mm. Inches in brackets.

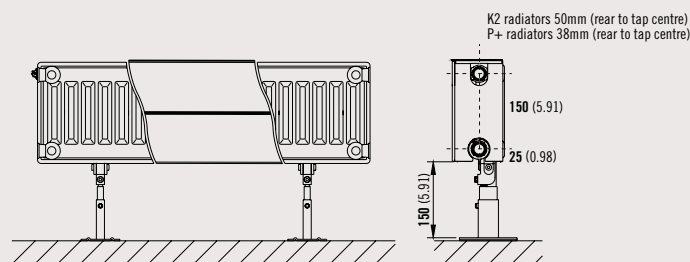

Floor mounting bracket comes as standard (200mm only).

CONNECTIONS

Each radiator comes with 1/2" inlet connections as standard.

Compact with Style Lo-Line Designer Series

PRESSURE DROPS

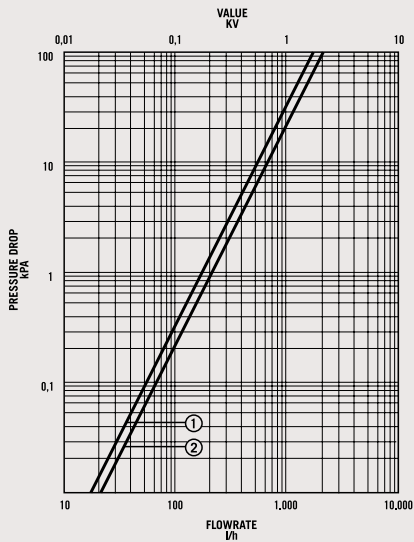

- ① Type 10 (P1), 11 (K1)
- ② Type 21 (P+), 22 (K2)

PANEL INFORMATION

All dimensions in mm. Inches in brackets.

P+ AND K2

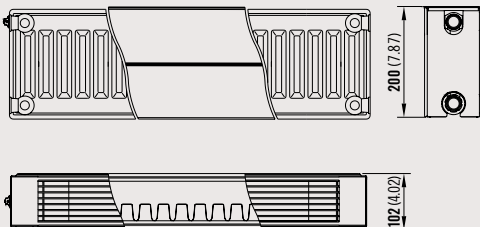

PIPING OPTIONS

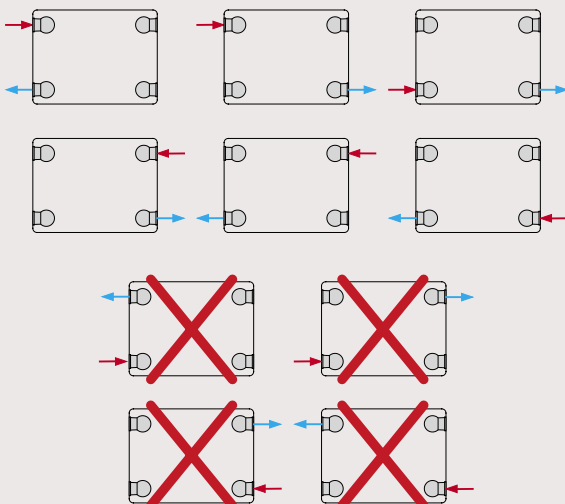

Colour Guide

A shade for every room, for every interior. Opt for warm elegance, baroque ambience or modern minimalism.

Colour information for the:

Vita Series - Vita Ultra*

Aqua Series - Caliente Rail, Caliente Curved Rail, Concord Rail & Vertical Ultra*

Designer Series - Compact with Style, Planar and Swing

Concept Series - Vita Column Concept****

Natural Colours



NT110
Papyrus white

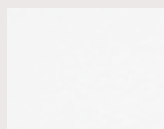

NT120
Pearl white

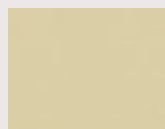

NT130
Champagne

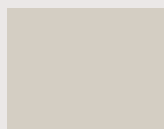

NT140
Beige

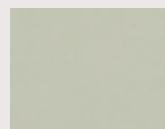

NT150
Beige grey

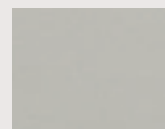

NT160
Pebble grey

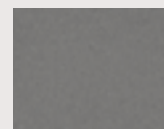

NT170
Quartz grey



SN110
Cream white



SN120
Cream



SN130
Mocca



SN140
Bordeaux



SN150
Sepia



SN160
Pale blue



SN170
Black

Metallic Colours

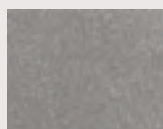

ML110
Dove grey

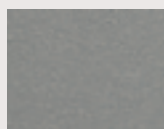

ML120
Titanium grey



ML130
Blue grey

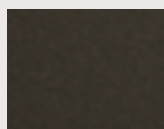

ML140
Granite

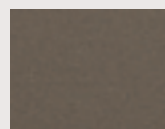

ML150
Cappuccino

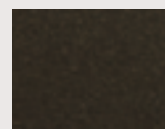

ML160
Terra brown



ML170
Graphite black

RAL Colours



A1004
Golden yellow



A2003
Pastel orange



A3002
Carmine red



A3003
Robin red



A5002
Ultramarine blue



A6018
Yellow green



A7001
Silver grey



A7011
Iron grey

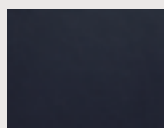

A7016****
Anthracite grey



A7030
Stone grey

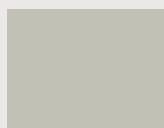

A7035
Light grey



A8017
Chocolate brown



A9003
Signal white



A9005
Jet black

*Please note: When choosing a colour only the front fascia panel can be coloured. Where the product height is 1000mm and 1200mm, the emitter, top grille and side panels are black. If the product height is 1800mm and 2000mm, the emitter, top grille and side panels are white.



RAL 9016**
Traffic white
comes as
standard on
all radiators.

Stelrad Radiators are available in white (RAL 9016) as standard, however the specific Radiators identified are now available in a variety of colours. The colours shown are reproduced as accurately as this process will allow and can be made to order on the identified products.

All colour radiators have up to an 8 week lead time, and when a coloured radiator or radiators have been ordered they cannot be cancelled or returned.

To request a colour chart please email
marketing@stelrad.com

Where indicated products are only available in this colour: ****Concept Series.

For further information on RAL colours please visit www.ralcolor.com