

plumbworld

Big brands, small prices.

600W Lifting Station MACERP600A

This unit is a pump that will clear the waste from a toilet, domestic shower and washbasin etc. The unit is gravity fed from a toilet, shower and wash basin. It has a built-in pressure switch which detects the incoming waste and starts the pump automatically.

Water temperature should be a minimum of 1°C and it is important that the unit does not freeze. Maximum water temperature is 45°C.

Electrics: The unit must be installed to comply with current UK electrical regulations, with a fused spur rated at 3 amps. We advise that this is done by a qualified professional installer.

This appliance must be earthed. If the supply cord is damaged, it must be replaced by a qualified person. The cable type is H05VV-F, 3G0.75mm² VDE. The IP rating of this appliance is IP54.

List of items included

- 1 x Outlet elbow connector
- 4 x Jubilee clips
- 2 x Inlet blocking cap
- 1 x Inlet toilet blocking cap
- 2 x Inlet connectors
- 1 x Floor fitting tools



Connecting to inlets

Use the rubber connectors to connect pipes to the toilet, one or both of the side inlets and secure with jubilee clips. If only using one in-let, close off the second with the blocking cover cap.

Connecting to toilet waste

The toilet should be with the standard horizontal outlet, with EU standard 18cm to the outlet center from the floor. The toilet must also have a flushing tank or tap. Place this horizontal toilet outlet into the macerator, and clamp the rubber sleeve of the macerator around the pipe using the supplied jubilee clip.

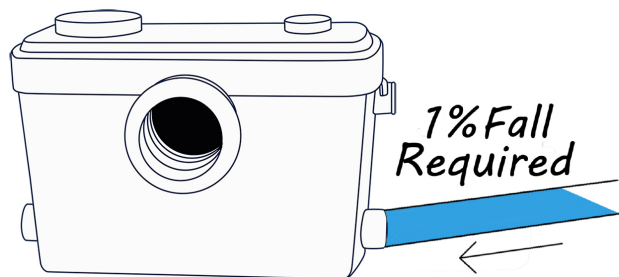
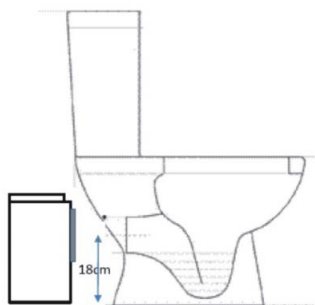

Connecting to shower or basin waste

Connect pipework to the lifting station at one end as above 'connecting to inlets' and then connect to the shower waste at the other end. Ensure that the shower waste exit is 85mm above the level of the lifting station inlet to ensure a gradient for the water to flow down to the unit. The gradient should be at least 1% (1cm per metre).

Connect pipework to the lifting station at one end as above 'connection to inlets' and then connect to the basin waste at the other end. The gradient should be at least 1% (1cm per metre).

600W Lifting Station MACERP600A

Outlet connection

A check valve has been pre-installed within this macerator unit. Normally the installer does not need to install additional check valves on the outlet pipework.

Push the outlet elbow connector into the unit and secure with a jubilee clip. See the following picture.

Horizontal runs of pipework should have a fall of 1%.

The outlet comes as standard with a 32mm connection however 22mm can be used with a reducer. If using bends in the connecting pipe work ensure they are smooth curves to avoid blockages. Allow a reduction of 0.5m per bend introduced, see Fig A for example.

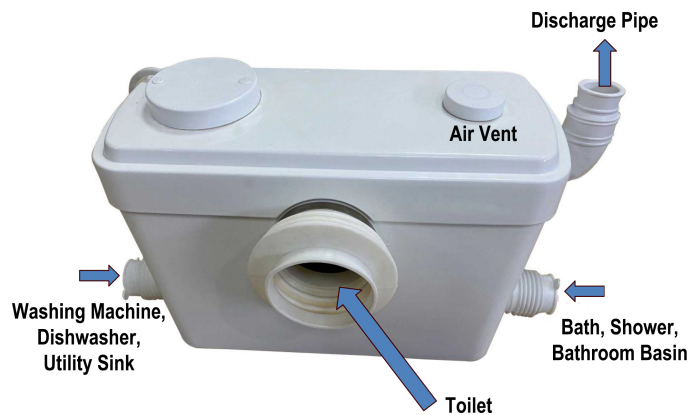

Air vent: normally NO need to connect with pipe.

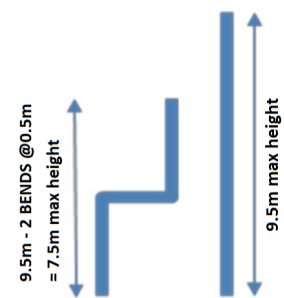
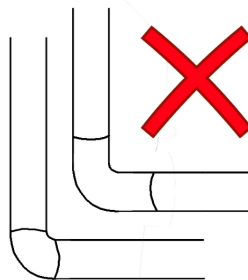
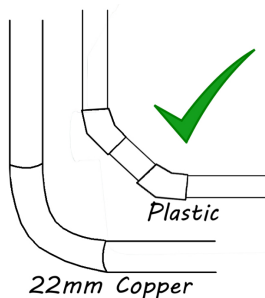

Fig A

Technical information

- Motor Power—600W
- Motor Duty Rating—S2
- Maximum Vertical Pumping Distance—9.5 metres
- Maximum Horizontal Pumping Distance—90 metres
- Maximum Water Temperature— 45°C
- Minimum Shower Waste Height—85mm

600W Lifting Station MACERP600A

Pumping distances and heights

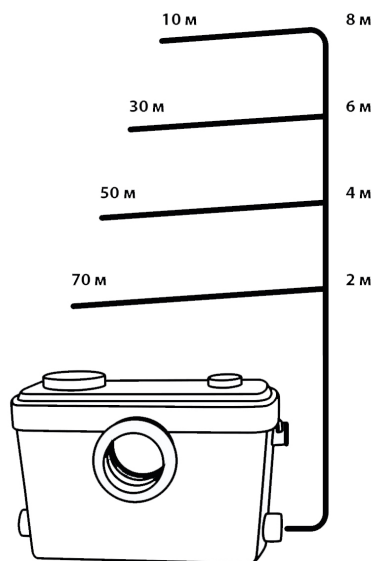

General Usage Guidelines

This unit is suitable for domestic indoor use only.

This lifting station is not only to be used for toilet, but also to take waste water from a shower and wash basin etc.

Do not put chemicals, acid, solvents, paints or foreign items through the lifting station as they will damage the unit and invalidate the warranty.

All servicing and maintenance should be carried out by a qualified professional only.

Cleaning should be undertaken every 6 months. The electric supply must be off before any servicing or maintenance is attempted. Always wear appropriate PPE when carrying this out.

Guarantee

This unit is guaranteed for one year against manufacturing defects.

Failure to install the appliance in accordance with this guide, installation by unqualified persons, foreign objects in the system and failure to carry out regular servicing and maintenance will invalidate the warranty.

Product Disposal

This product should not be disposed of with other household waste.

To prevent possible harm to the environment or human health from uncontrolled waste disposal, the unit should be disposed of at an appropriate local authority facility.

The symbol on the appliance states that it meets the new directive (2012/19/EU) and must be handled in accordance with this standard at the end of its service life.

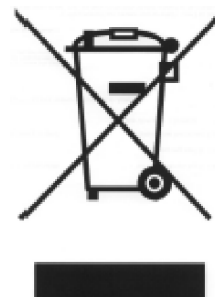

600W Lifting Station MACERP600A

Trouble Shooting

Symptom	Cause	Resolution
The macerator has cut out	The device has overheated.	Leave the unit to cool for 30 mins, switch it back on and hold the override switch to reset the unit. Check for blockages.
The macerator has cut out	Power supply has been interrupted	Check fuses and power supply.
The water is back flowing	Insufficient gradient	Ensure a gradient of 1cm per meter is used.
The unit is leaking.	Check valve/jubilee clips are not fitted correctly.	Check these items.
The macerator is non-operational and has never been opened.	The macerator is connected to an incorrect size pipe.	Ensure the pipe is 32 or 40mm.
	The electrical install was incorrect.	Ensure the device was installed by a qualified person.
	The check valve is facing in the wrong direction.	Check the check valve(s).
	Pressure switch is blocked	Check/replace the pressure switch.
The macerator is not powerful enough.	Discharge pipes are too long/high	Check the distances against the spec.
	Discharge pipe is too small	Check the sizes
	Unit is blocked.	Service as per instructions above.
The macerator emits a humming noise but does not discharge waste.	Pump is blocked	Check/service pump.
	Check valve is installed the wrong way round.	Check the check valve.
The macerator discharges waste with no demand.	Check valve is faulty	Examine/replace the check valve.
	The tank is leaking	Check the tank.
	There is a partial blockage	Clear the blockage
	Pressure switch is defective	Replace the pressure switch
Macerator is not emitting a humming noise.	The unit is not properly connected to the electric supply	Check the supply