

Vented taps

Streamline 1000

Streamline 2000

Streamline 2000 elbow lever

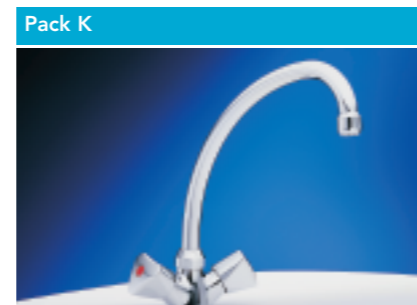

Pack M

Pack P

Pack Q



Ordering guide	
	Product code
Streamline 1000* † A standard monobloc mixer tap	95:970:344
Streamline 2000* † A monobloc mixer tap with pop-up waste fitting. (Pop-up waste fitting suitable for ceramic sinks only)	95:970:345
Streamline 2000 with elbow lever* † A monobloc mixer tap with elbow lever (suitable for surgical/medical environments) and pop-up waste fitting (Pop-up waste fitting suitable for ceramic sinks only)	95:970:346
Oversink accessories Streamline	
Pack B Standard spout and valve	95:970:327
Pack C Telescopic spout (380-610mm) and valve	95:970:329

*IMPORTANT: Streamline 1000/2000 for sinks and basins with 37.0mm to 39.0mm tap holes.
 † Product appearance may vary slightly from that shown. Performance and function will remain the same.

Ordering guide	
Undersink accessories Streamline, Express and UTC	
Pack J † Two-hole mixer tap. Chrome plated and elegantly styled	95:970:295
Pack K † Monobloc mixer tap. A graceful design, ideal for the modern kitchen	95:970:296
Pack M † Elbow pillar tap. (Hot and cold taps supplied) 1/4 turn lever, ideal for surgical/medical environments	95:970:298
Pack P † Elbow basin tap. (Hot and cold taps supplied) 1/4 turn lever, ideal for surgical/medical environments	95:970:299
Pack Q † Two-hole elbow mixer tap. 1/4 turn levers, ideal for surgical/medical environments	95:970:310
Pack R † Pillar tap. (Hot and cold taps supplied)	95:970:311
Pack S † Basin hot tap.	95:970:312
Pack T † Basin cold tap. (Cold tap only to match Pack S)	95:970:313
Pack Z † Splash guard with two connectors. Enables existing vented taps to be used when a new Streamline unit replaces an earlier Heatrae Sadia undersink water heater. Note: The splash guard and connectors are included in all vented tap packs.	95:970:319

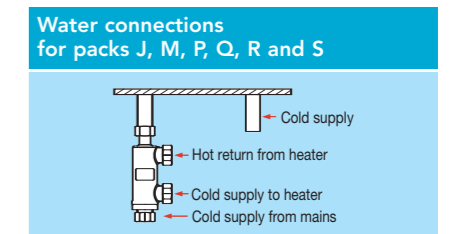

Oversink taps and accessories

(For use with Streamline only)

Streamline 1000*†

A standard monobloc mixer tap.

Streamline 2000*†

A monobloc mixer tap with pop-up waste fitting (pop-up waste fitting suitable for ceramic sinks only).

Streamline 2000 elbow lever*†

A monobloc mixer tap with elbow lever and pop-up waste fitting, ideal for surgical / medical environments (pop-up waste fitting suitable for ceramic sinks only).

Pack B Standard spout and valve.

Pack C Telescopic spout (380-610mm) valve.

Undersink taps and accessories

(For use with Streamline, Express and UTC 99)

Pack J†

Two-hole mixer tap. Chrome plated and elegantly styled.

Pack K†

Monobloc mixer tap. A graceful design, ideal for the modern kitchen.

Pack M†

Elbow pillar tap. ¼ turn lever, ideal for surgical / medical environments (hot and cold taps supplied).

Pack P†

Elbow basin tap. ¼ turn lever, ideal for surgical / medical environments (hot and cold taps supplied).

Pack Q†

Two-hole elbow mixer tap. ¼ turn levers, ideal for surgical / medical environments.

Pack R†

Pillar tap (hot and cold taps supplied).

Pack S†

Basin hot tap.

Pack T†

Basin cold tap (cold tap only to match Pack S).

Pack Z – Streamline only[°]

Splash guard with two connectors. Enables existing vented taps to be used when a new Streamline unit replaces an earlier Heatrae Sadia undersink water heater.

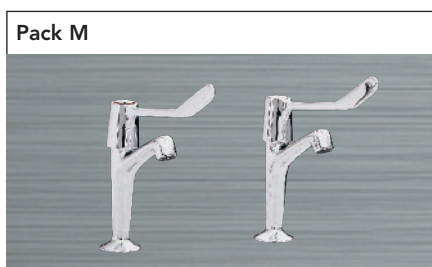
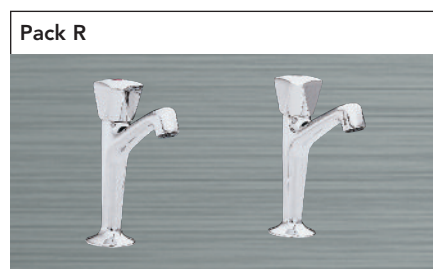
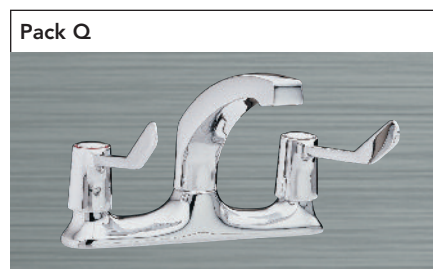
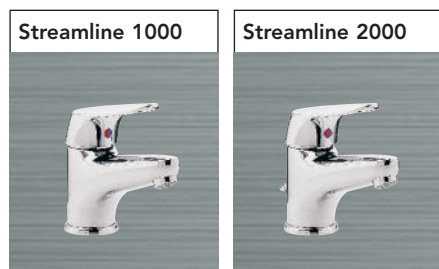

* IMPORTANT: Streamline 1000 / 2000 for sinks and basins with 37 to 39mm tap holes.

† Product appearance may vary slightly from that shown. Performance and function will remain the same.

[°] The splash guard and connectors are included in all vented tap packs.

Accessory dimensions and ordering

Streamline 1000

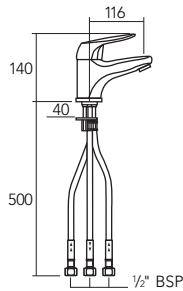

Streamline 2000

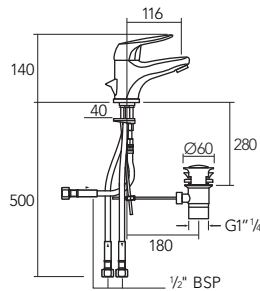

Streamline 2000 elbow lever

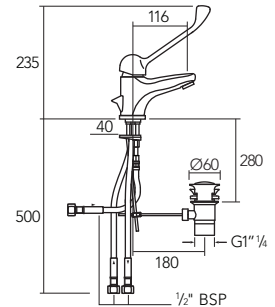

Pack J

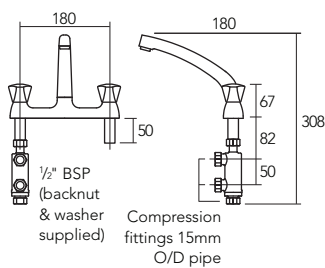

Pack K

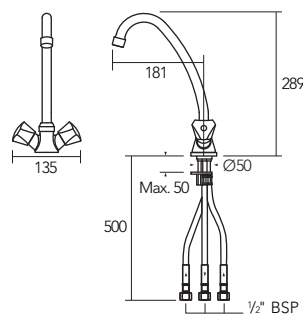

Pack M

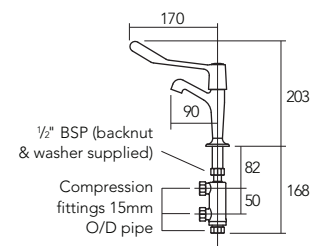

Pack P

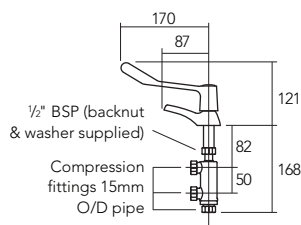

Pack Q

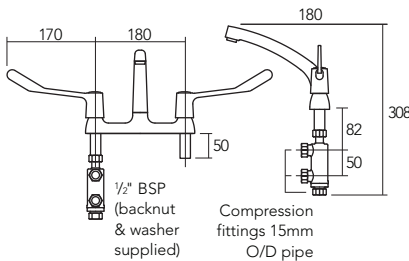

Pack R

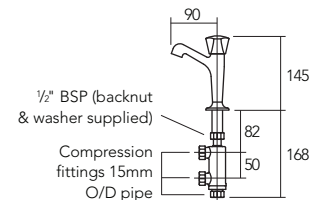

Pack S

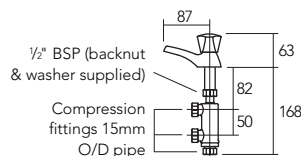

Pack T

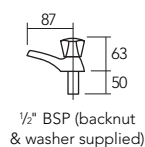

Connections for Packs J, M, P, Q, R and S

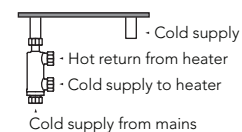

Ordering guide – oversink accessories

Model	Product code
Streamline 1000*†	95:970:344
Streamline 2000*†	95:970:345
Streamline 2000 with elbow lever*†	95:970:346
Pack B	95:970:327
Pack C	95:970:329

* IMPORTANT: Streamline 1000 / 2000 for sinks and basins with 37 to 39mm tap holes.
† Product appearance may vary slightly from that shown. Performance and function will remain the same.

Ordering guide – undersink accessories

Model	Product code
Pack J†	95:970:295
Pack K†	95:970:296
Pack M†	95:970:298
Pack P†	95:970:299
Pack Q†	95:970:310
Pack R†	95:970:311
Pack S†	95:970:312
Pack T†	95:970:313
Pack Z†	95:970:319