

PLEASE RESPECT YOUR ENVIRONMENT!
Take care to dispose of this product and any packaging or literature in an appropriate way



WHAT IS A PROGRAMMER?

...an Explanation for Householders (as recommended by the Energy Savings Trust)

Programmers allow you to set 'On' and 'Off' time periods. Some models switch the central heating and domestic hot water on and off at the same time, while others allow the domestic hot water and heating to come on and go off at different times. Set the 'On' and 'Off' time periods to suit your own lifestyle. On some programmers you must also set whether you want the heating and hot water to run continuously, run under the chosen 'On' and 'Off' heating periods, or be permanently off. The time on the programmer must be correct. Some types have to be adjusted in spring and autumn at the changes between Greenwich Mean Time and British Summer Time. You may be able to temporarily adjust the heating programme, for example, 'Override', 'Advance', or 'Boost'. These are explained in the manufacturer's instructions. The heating will not work if the room thermostat has switched the heating off. And, if you have a hot-water cylinder, the water heating will not work if the cylinder thermostat detects that the hot water has reached the correct temperature.



WHAT IS A ROOM THERMOSTAT?

...an explanation for Householders (as recommended by the Energy Savings Trust)

A room thermostat simply switches the heating system on and off as necessary. It works by sensing the air temperature, switching on the heating when the air temperature falls below the thermostat setting, and switching it off once this set temperature has been reached. Turning a room thermostat to a higher setting will not make the room heat up any faster. How quickly the room heats up depends on the design of the heating system, for example, the size of boiler and radiators. Neither does the setting affect how quickly the room cools down. Turning a room thermostat to a lower setting will result in the room being controlled at a lower temperature, and saves energy. The heating system will not work if a time switch or programmer has switched it off. The way to set and use your room thermostat is to find the lowest temperature setting that you are comfortable with, and then leave it alone to do its job. The best way to do this is to set the room thermostat to a low temperature – say 18°C – and then turn it up by one degree each day until you are comfortable with the temperature. You won't have to adjust the thermostat further. Any adjustment above this setting will waste energy and cost you more money.

If your heating system is a boiler with radiators, there will usually be only one room thermostat to control the whole house. But you can have different temperatures in individual rooms by installing thermostatic radiator valves (TRVs) on individual radiators. If you don't have TRVs, you should choose a temperature that is reasonable for the whole house. If you do have TRVs, you can choose a slightly higher setting to make sure that even the coldest room is comfortable, then prevent any overheating in other rooms by adjusting the TRVs.

Room thermostats need a free flow of air to sense the temperature, so they must not be covered by curtains or blocked by furniture. Nearby electric fires, televisions, wall or table lamps may prevent the thermostat from working properly.

Honeywell Control Systems Ltd.

Arlington Business Park,
Bracknell
Berkshire
RG12 1EB

Technical Help Desk: 08457 678999
www.honeywelluk.com

50047645-008 A

© 2011 Honeywell International Inc.



User Guide

Y9420S Sundial RF² Pack 3

How to use:

ST9420C Wireless Enabled Programmer

DT92E Wireless Room Thermostat





CS92A Wireless Cylinder Thermostat

BDR91T Wireless Enabled Relay Box (if installed)

**This document is to be left with the user
and forms part of a Home Information Pack**

System Components

This section is to be completed by the Installer

		Location
ST9420C		
DT92E		(typically in living room or hallway)
CS92A		(typically next to hot water tank, in bedroom)
BDR91T		(If installed, typically next to boiler)

Energy Efficiency and the Environment

Home energy use is responsible for more than ¼ of the total UK carbon emissions which contribute to climate change. Heating and hot water systems based on boilers account for ⅔ of this figure, so it is important to understand how your controls can help to maximize energy efficiency while maintaining your comfort.

Your Programmer should be used in conjunction with appropriate temperature controls. In order to save energy the following general points should be observed:

1. Ensure your system contains a room thermostat and a hot water thermostat, and that both are set to appropriate temperature levels: typically 20°C for the room temperature and between 50 - 60°C for the hot water temperature.
2. Programme your heating and hot water to be off when you are not in the house. If you are concerned about possible frost damage to any exposed pipe work, it is advisable to fit a frost protection system – your installer can advise you about this.
3. Think about how you use your domestic hot water – if you have a storage system, it is not necessary to have this switched on all the time, even when you are in the house.
4. Consider the heat up times required for your central heating. Every home responds differently when the heating is switched on. Adjust the start time so that you are not cold when you get up in the morning. A shorter heat up time is required for other heating periods.
5. In the evening, when the house is up to temperature, it is often possible to switch off the heating up to an hour before you go to bed, without any noticeable reduction in comfort.

ST9420C CONTROLS LAYOUT

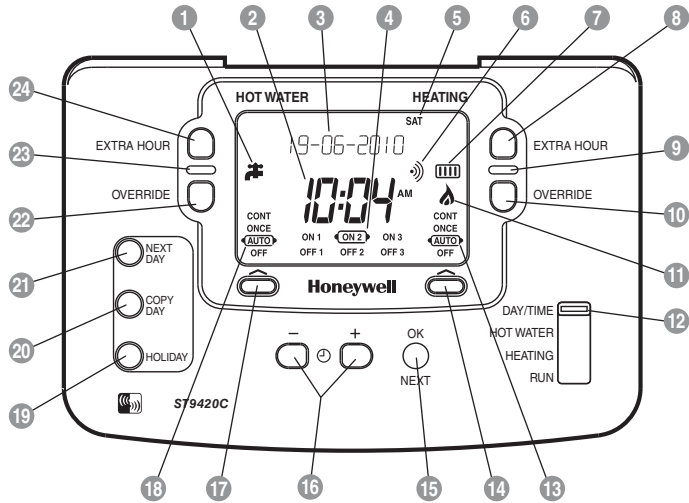

- 1 Hot Water 'ON' period indicator
- 2 Time Display
- 3 LoT™ Technology Display
- 4 Programme Time Markers
- 5 Day of Week Indicator
- 6 RF Symbol
- 7 Heating 'ON' period indicator
- 8 Heating Extra Hour Button
- 9 Heating Indicator Lamp
- 10 Heating Override Button
- 11 Boiler Status Indicator
- 12 Slider
- 13 Heating Operating Mode Indicator
- 14 Heating Operating Mode Button
- 15 OK/Next Button
- 16 Clock – and + Buttons
- 17 Hot Water Operating Mode Button
- 18 Hot Water Operating Mode Indicator
- 19 Holiday Button
- 20 Copy Day Button
- 21 Next Day Button
- 22 Hot Water Override Button
- 23 Hot Water Indicator Lamp
- 24 Hot Water Extra Hour Button

Keep this document in a Home Information Pack

DT92E CONTROLS LAYOUT

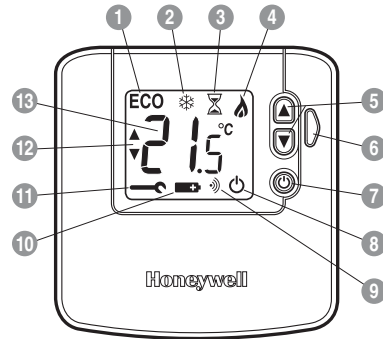

- 1 ECO Mode Active
- 2 Frost Protect Indicator
- 3 ECO Countdown Indicator
- 4 Heating Demand Indicator
- 5 Setpoint Change Buttons
- 6 ECO Button
- 7 OFF/Standby Button
- 8 OFF/Standby Indicator
- 9 RF Communications Indicator
- 10 Battery Low Indicator
- 11 Fault Indicator
- 12 Setpoint Indicator
- 13 Temperature Display

CS92A CONTROLS LAYOUT

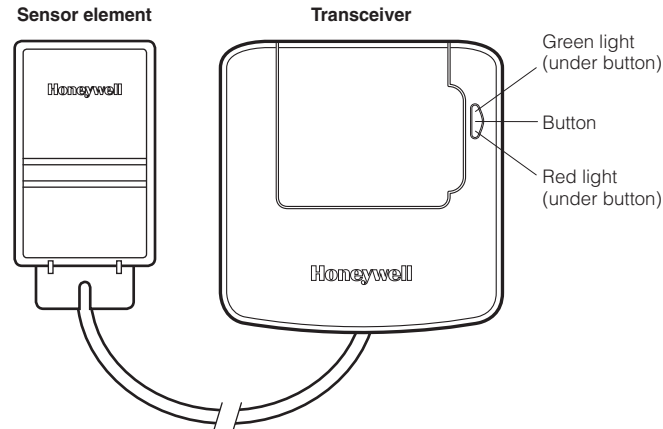

CONFIGURATION & SERVICE DATA

Configurable Features	Options	Factory setting	Installer configured (note value)
DT92E Configuration			
Measurement offset	-3.0°C to 0 to 3.0°C	0	
Upper setpoint limit	21 to 35°C	35°C	
Lower setpoint limit	5 to 21°C	5°C	
Energy saving ECO setpoint	5 to 35°C	18°C	

Boiler & System Service Log

The space below can be used to provide a record of boiler & system services and the names and contact numbers of the Installer and Service Personnel.

This information is important for a Home Information Pack.

Service/Installation Date	Installation/Service Engineer	Telephone Number / Contact Details

This product and its associated documentation and packaging are protected by various intellectual property rights belonging to Honeywell Inc. and its subsidiaries and existing under the laws of the UK and other countries. These intellectual and property rights may include patent applications, registered designs, unregistered designs, registered trade marks, unregistered trade marks and copyrights.

Honeywell reserves the right to modify this document, product and functionality without notice. This document replaces any previously issued instructions and is only applicable to the product(s) described.

This product has been designed for applications as described within this document. For use outside of the scope as described herein, refer to Honeywell for guidance. Honeywell cannot be held responsible for misapplication of the product(s) described within this document.

Manufactured for and on behalf of the Environmental and Combustion Controls Division of Honeywell Technologies Sàrl, ACS-ECC EMEA, Z.A. La Pièce 16, 1180 Rolle, Switzerland by its Authorised Representative Honeywell Inc.

Contents

CONTROL OF YOUR SYSTEM

General Description of Controls in Your System.....	4
The way to use a Programmer.....	4
The way to use a Room Thermostat / Control of Your Boiler / Optimisation	5

GETTING STARTED WITH YOUR ST9420C

Step 1: Setting the Date & Time.....	6
Step 2: Running a Built-in Programme	7

PROGRAMMING YOUR ST9420C

The Built-in Programmes / Your Personal Programme.....	8
Reviewing the Programme Times / Modifying the Hot Water Programme.....	9
Modifying the Heating Programme / Disabling or Enabling Time Periods	11

OPERATING YOUR ST9420C

Choosing the Operating Mode	12
Overriding the Operation Without Changing the Programmes.....	12
The Extra Hour Function / The Holiday Function	13
Enquiry Mode	14

FINE TUNING YOUR ST9420C

Changing from AM/PM Time Display to the 24 Hour Clock.....	15
Changing the Installer Parameters	15
Optimisation.....	17
How to set your Hot Water Set Temperature.....	18

BOILER SERVICE REMINDER

Countdown to Service / When Service is Due	18
Shut-down.....	19

OPERATING YOUR DT92E

Inquiring about the Set Temperature / Adjusting the Set Temperature.....	19
Switching Off / Display Updates / Heating Indicator / Frost Protection	20

DT92E OPERATING INDICATORS

Low Battery Indicator / Battery Replacement / RF Communications Indicator / Lockout ...	21
---	----

DT92E ENERGY SAVING ECO FEATURE

Entering ECO Mode and Setting the Energy Saving Time Period.....	22
What Happens in ECO Mode?.....	22
How to Exit ECO Mode.....	23

FINE TUNING YOUR DT92E

Changing the DT92E Installer Parameters	23
---	----

OPERATING YOUR CS92A HOT WATER THERMOSTAT

Basic Operation / Battery Replacement / Error Indications.....	25
--	----

OPERATING YOUR BDR91T RELAY BOX (IF INSTALLED)

BDR91T Controls Layout / Automatic Operation	26
Temporary Manual Override / Loss of Wireless Communications	26

FAQ AND TROUBLESHOOTING

Frequently Asked Questions.....	27
Troubleshooting Guide.....	29

CONFIGURATION & SERVICE DATA

Configuration Data (to be completed by Installer)	34
Boiler & System Service Log	35

General Description of Controls in Your System

Your Honeywell ST9420C provides timing control for both your central heating and hot water systems, letting you set **ON** and **OFF** periods to suit your own lifestyle.

The ST9420C does not directly control the temperature but works together with other temperature controls, such as room thermostats and cylinder thermostats or sensors, to control your heating and hot water system in your home.

With 7-day programming and up to 3 on/off periods per day, every day can be set differently, and heating and hot water can be set at different times from each other.

ST9420C also has a Boiler Service reminder / Shut-down feature, which helps ensure your gas boiler is regularly serviced in compliance with UK Gas Safety Regulations. For more details see pages 18 & 19.

Your system includes a DT92E wireless room thermostat and may include a BDR91T Relay Box to switch your boiler remotely. These products use state of the art 2 way RF communications to share information and give you robust and flexible control of your indoor environment.

The following instructions explain how to programme and use the ST9420C, and associated controls, to provide the most home comfort at the least cost.

The way to use a Programmer

Think about the time periods when you are typically in the house and when you are not, and also the times when you use a lot of hot water. These are the times you should use as the basis for the programmes. It will be necessary to allow some heat up time for the heating system after periods when it has been off – this would typically be 1 - 1½ hours, depending on your house and your preferences.

If Optimum Start has been selected (see page 17), you do not have to allow for this heat up time as the Programmer is intelligent and will calculate the correct starting time for your house. This is based on measurements it makes about your system characteristics, and on the current and target room temperatures. All you have to do is programme the time periods when you want to be comfortable.

Other features are commonly available on the Programmer to enhance comfort and convenience, for example, **OVERRIDE**, **EXTRA HOUR**, and **MODE** buttons.

A typical use of the **OVERRIDE** feature is when you return home unexpectedly for the rest of the day and the heating is off. Just press the heating **OVERRIDE** button and the heating will come on until the next programme time, at which point it will follow the normal programme. The advantage here is that you do not have to remember to switch off because the normal time programme does this for you.

A typical use of the **EXTRA HOUR** button would be if you returned to the house for a short period when the heating and hot water were off. Pressing the appropriate **EXTRA HOUR** button gives you 1, 2, or 3 hours of heating, exactly when you need it. Another typical use is when the heating is already on and you want it to stay on a little longer - just press **EXTRA HOUR** and, for that day only, an hour will be added to the end of the time at which heating normally goes off.

The **MODE** buttons allow you to select how you want to operate heating and hot water independently. The most obvious use is to switch heating **OFF** during the summer months, but you may also use this feature if you take a mid-week day off work, you can then set the **MODE** to **ONCE** to keep the system **ON** during the day from the first programmed **ON** time till the last programmed **OFF** time.

The way to use a Room Thermostat

The way to set and use your room thermostat is to find the lowest temperature setting that you are comfortable with, and then leave it alone to do its job. The best way to do this is to set the room thermostat to a low temperature – say 18°C – and then turn it up by one degree each day until you are comfortable with the temperature. You won't have to adjust the thermostat further. Any adjustment above this setting will waste energy and cost you more money.

DT92E has a green **ECO** button, which enables you to set a period of time at a lower temperature. This energy saving feature is most useful if you are out of the house for a few hours, or if you want a reduced temperature for a while and don't want to have to remember to turn the temperature back up (see pages 22 & 23 for details).

Control of Your Boiler

There are two ways your boiler may be controlled. It may be switched directly using the ST9420C timer, or, if installed in a remote location, it may be switched using a BDR91T relay box.

In each situation the operation of the boiler is determined automatically by the combination of inputs from the room thermostat and the timer, and in such a way as to maintain your comfort with minimal energy use. The timer will indicate the on/off status of the boiler by showing the flame symbol .

Optimisation (see page 17 for explanatory diagrams)

Your control system has some features called Optimisation, which aim to save energy while making you as comfortable as possible. These may or may not be enabled – check page 34 where your Installer should have indicated how these were set. **Optimisation does not apply to your Hot Water, only to your Heating.**

Optimum Start works by measuring how quickly your system normally heats up, and

CONTROL OF YOUR SYSTEM

using this to calculate the correct time to switch on to reach your comfort temperature, when you want it. **So the times you set are when you want the heating to be at the correct temperature, and the system adjusts the starting time to meet this.**

Delayed Start is an alternative to Optimum Start. It works by using your normal programmed start times, compares the actual temperature with the set temperature, and delays the start a little depending on how close these temperatures are to each other.

Optimum Stop saves energy, and money, by switching off a little earlier than the normal programme time. If the house is up to temperature, you will not notice the effect on the temperature, but you will see a difference in your fuel bill.

The radiator symbol on ST9420C will flash to let you know whenever Optimisation is operating.

The other controls in your system should not require adjustment.

GETTING STARTED WITH YOUR ST9420C

Your ST9420C should have been set up to work correctly when it was installed. However, the following will show you how you can modify your settings to meet your particular lifestyle.

To assist you with programming and everyday use your ST9420C will display text messages at every stage to help you get the most out of your central heating and hot water system. The ST9420C uses LoT™ Technology to constantly update the display to give you feedback about what is required.

Step 1: Setting the Date & Time

Your ST9420C had the date and time set at the factory, and these are normally maintained by a backup battery in the event of power failures. If you wish to change the date or time, or if the LoT™ Display shows the message 'SET DATE + TIME' just follow the instructions below. Otherwise, go to **Step 2**.

- a. Move the slider to the **DAY/TIME** position. The message 'SET DATE + TIME' will show briefly on the screen, followed by 'SET THE DAY', and the day of the month will now be flashing to indicate it can be changed.

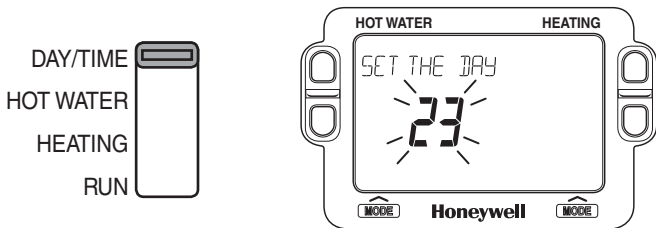

- b. To change the day of the month, press the \ominus $\omin�$ or \oplus buttons until the correct day is shown. Each press of the button will change the date by one day. As soon as a change has been made, the message 'IS DAY OK?' will be displayed. Once the correct day is reached, press the green OK button to confirm, and move to the next step. If you do not need to make a change, just press the OK button immediately and this will move you to the next step.
- c. The month digits will now be flashing and 'SET THE MONTH' will be displayed. To change the month, press the \ominus $\omin�$ or \oplus buttons until the correct month is shown. The message 'IS MONTH OK?' will be displayed. Press the green OK button to confirm the month is correct and move to the next step.
- d. The year digits will now be flashing and 'SET THE YEAR' will be displayed. To change the year, press the \ominus $\omin�$ or \oplus buttons until the correct year is shown. The message 'IS YEAR OK?' will be displayed. Press the green OK button to confirm the year is correct. If you have made a change and the date is a valid date, the message 'DATE SAVED' will show, and you can move to the next step. If the date you set was not valid, for example 31 September, the message 'INVALID' will show and you will be returned to the start of the date setting operation.
- e. The time will now be flashing and the message 'SET THE TIME' will be displayed. To change the time, press the \ominus $\omin�$ or \oplus buttons until the correct time is shown. Each press of the button will change the time by one minute. Holding the button down for more than a few seconds will change the time slowly at first, then quickly. The message 'IS TIME OK?' will be displayed. Press the green OK button to confirm the time is correct. If you have made a change, the message 'TIME SAVED' will show, followed quickly by 'DATE + TIME COMPLETE'.
- f. Move the slider to the **RUN** position to complete setting the date and time.

Note: if the slider is moved at any time before the date and time have been set correctly, the message 'DATE UNCHANGED' will be displayed briefly, and your changes will not be saved.

Step 2: Running a Built-in Programme

With the date and time correct, your ST9420C Programmer will now be operating to the built-in programmes. These have been designed to provide heating and hot water at typical times throughout the day, but if you want to customise the settings, please see the next section '**PROGRAMMING YOUR ST9420C**' (page 8).

The Built-in Programmes

The built-in programmes give you a starting point that you can personalise to your own requirements. Your Installer should have selected one and ticked the box alongside it. If there is no tick, the product normally leaves the factory with Profile A installed, but it is a simple matter to select one of the other profiles (see **Changing the Installer Parameters**, page 15).

Built-in Programme (Profile A)

		ON 1	OFF 1	ON 2	OFF 2	ON 3	OFF 3
Monday to Friday	Heating	6:30am	8:30am	12:00pm	1:00pm	4:30pm	10:30pm
	Hot Water	6:30am	8:30am	12:00pm	1:00pm	4:30pm	10:30pm
Saturday & Sunday	Heating	6:30am	9:30am	12:00pm	1:00pm	4:30pm	11:00pm
	Hot Water	6:30am	9:30am	12:00pm	1:00pm	4:30pm	11:00pm

Built-in Programme (Profile b)

		ON 1	OFF 1	ON 2	OFF 2	ON 3	OFF 3
Monday to Friday	Heating	6:30am	9:30am	12:00pm	1:00pm	4:30pm	11:00pm
	Hot Water	6:30am	9:30am	12:00pm	1:00pm	4:30pm	11:00pm
Saturday & Sunday	Heating	6:30am	9:30am	12:00pm	1:00pm	4:30pm	11:00pm
	Hot Water	6:30am	9:30am	12:00pm	1:00pm	4:30pm	11:00pm

Built-in Programme (Profile C)

		ON 1	OFF 1	ON 2	OFF 2	ON 3	OFF 3
Monday to Friday	Heating	6:30am	7:30am	12:00pm	12:00pm	5:00pm	10:00pm
	Hot Water	6:30am	7:30am	12:00pm	12:00pm	5:00pm	10:00pm
Saturday & Sunday	Heating	8:30am	9:30am	12:00pm	1:00pm	5:30pm	10:30pm
	Hot Water	8:30am	9:30am	12:00pm	1:00pm	5:30pm	10:30pm

Your Personal Programme

The table below has been left blank for you to record your own personal programme.

		ON 1	OFF 1	ON 2	OFF 2	ON 3	OFF 3
Monday	Heating						
	Hot Water						
Tuesday	Heating						
	Hot Water						
Wednesday	Heating						
	Hot Water						
Thursday	Heating						
	Hot Water						
Friday	Heating						
	Hot Water						
Saturday	Heating						
	Hot Water						
Sunday	Heating						
	Hot Water						

Reviewing the Programme Times

To review your hot water programme, move the slider to the **HOT WATER** position.

To review your heating programme, move the slider to the **HEATING** position.

To review the programme times, press the **OK** button repeatedly. The appropriate **ON** and **OFF** markers will be displayed to show you which time is being reviewed. Any of these times can be adjusted by using the **⌚** **-** or **+** buttons, and then confirmed using the **OK** button. Remember to return the slider to the **RUN** position after reviewing is complete.

Modifying the Hot Water Programme

The hot water programme has three pairs of **ON/OFF** switching times per day. Each time can be set between 3.00 am and 2.50 am (on the next day) to allow you to programme the hot water to stay on past midnight, if required.

- Move the slider to the **HOT WATER** position. 'SET HOT WATER' will show briefly to verify this action.

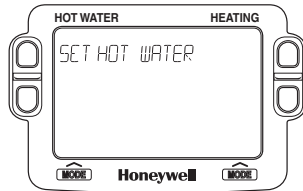
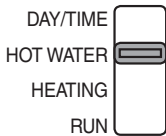

- 'SET ON-TIME 1' will then be displayed and the time setting for the first **ON 1** time for **MONDAY** will now be flashing to indicate it can be changed. If you do not wish to change the time, press the green **OK** button and move to the next step. If you do wish to make a change, use the **⌚** **-** or **+** buttons to change the first **ON 1** time. Each press of the button will change the time by 10 minutes. As soon as the time has been changed, the message 'ON-TIME 1 OK?' will be displayed. Press the green **OK** button to confirm the time is correct and move to the next step. 'SAVED' will be displayed for a moment to confirm that any change has been saved to memory.

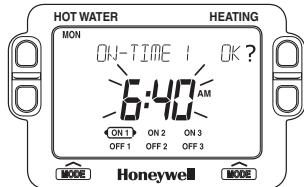
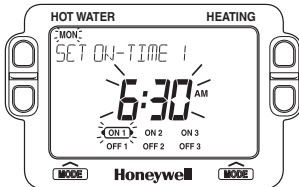

PROGRAMMING YOUR ST9420C

Note: When pressing the (+) button the next **ON** or **OFF** marker may start to flash. This indicates you have tried to set a time equal to one of the next programme times already in the memory. Similarly, when pressing the (-) button the previous **ON** or **OFF** marker may start to flash. This indicates you have tried to set a time equal to one of the previous programme times. If this happens the ST9420C simply moves both times together as long as you continue to press the (-) (+) or (+) (-) buttons. Follow the procedure in '**Reviewing the Programme Times**' (page 9) to check and adjust these times as necessary.

- c. 'SET OFF-TIME 1' will be displayed and the first **OFF 1** time will now be flashing. If you do not wish to change the time, press the green (OK) button and move to the next step. Otherwise, use the (-) (+) or (+) (-) buttons to change the time. Press the green (OK) button to confirm the time is correct and move to the next step. 'SAVED' will be displayed for a moment to confirm that any change has been saved to memory.
- d. The remaining **ON** and **OFF** times (ON 2, OFF 2, ON 3, OFF 3) can be set by using the (-) (+) or (+) (-) buttons to change the time then the green (OK) button to confirm the time is correct and move to the next step. If you do not wish to change the time, just press the green (OK) button to move directly to the next **ON/OFF** time without making any changes.
- e. After setting or reviewing the last off time, **OFF 3**, the message 'COMPLETE' will be displayed to indicate the times for Monday have been set.

You now have a choice of how to set the programme for the next day:

Copying One Day's Programme to Another Day (example Monday to Tuesday):

- f. Whilst the day is showing Monday, Press the **COPY DAY** button. The message 'COPY MON TO TUESDAY OK?' will be displayed and the letters **TUE** will flash to indicate the programme for Monday can be copied to Tuesday.
- g. To select a different day to copy to, press the **NEXT DAY** button to cycle through the days. With each press of the **NEXT DAY** button the message will change to indicate the new day you are copying to.
- h. When the required day is indicated, press the green (OK) button to confirm, and the message 'MON COPIED' will be displayed for a moment. The day into which Mondays programme has been copied is now available to have its programme edited.

Note: Once a day's programme has been confirmed in this way, it now becomes the day whose programme is copied if the **COPY DAY** button is pressed again.

OR

Programming a Different Day:

- i. Press the **NEXT DAY** button to select the next day, which is displayed along the top of the screen. The programme for that day can then be adjusted by following steps **b** – **e** above. Programmes for the remaining days can be set in the same way, using the **NEXT DAY** button to move to the next day.

Exiting HOT WATER Programming Mode:

To exit **HOT WATER** programming mode, move the slider to the **RUN** position. This can be done at any time during the programming process, and any changes made and confirmed with the **OK** button will have been saved.

Note: If the unit is left in **HOT WATER** Programming mode for more than 10 minutes without the slider being moved or any buttons pressed, the message 'MOVE SLIDER' will be displayed. Press a button to continue programming, or move the slider to the **RUN** position.

Modifying the Heating Programme

The heating programme has three pairs of **ON/OFF** switching times per day. Each time can be set between 3.00 am and 2.50 am (on the next day) to allow you to programme the heating to stay on past midnight, if required.

- a. Move the slide switch to the **HEATING** position. 'SET HEATING' will show briefly to verify this action.

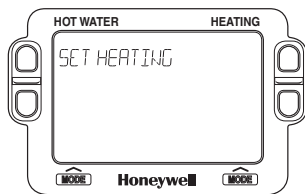
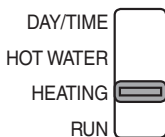

- b. Now follow the same procedure to set the times as described in 'Modifying the Hot Water Programme' (page 9) steps **b.** to **i.**

Exiting HEATING Programming Mode:

To exit **HEATING** programming mode, move the slider to the **RUN** position. This can be done at any time during the programming process, and any changes made and confirmed with the **OK** button will have been saved.

Note: If the unit is left in **HEATING** Programming mode for more than 10 minutes without the slider being moved or any buttons pressed, the message 'MOVE SLIDER' will be displayed. Press a button to finish programming, or move the slider to the **RUN** position.



Disabling or Enabling Time Periods (for Heating and/or Hot Water)

To disable any of the time periods **ON 1** to **OFF 1**, **ON 2** to **OFF 2**, or **ON 3** to **OFF 3**, simply set the **ON** time and its paired **OFF** time to the same time, and the programme will just ignore them.

To re-enable the time period, simply set the two **ON** and **OFF** times to be different.

Choosing the Operating Mode (for Heating and/or Hot Water)

The operating mode may only be changed when the slider is set to the **RUN** position.

The  symbol is displayed during a programmed heating on period, and a  symbol is displayed during a programmed hot water on period. A green **INDICATOR LAMP** shows when the heating or hot water is switched **ON**.

Two **MODE** buttons are provided to select the Operating Mode and therefore how the heating and hot water are controlled.

Heating has four possible **Operating Modes**; these are **OFF**, **AUTO**, **ONCE**, **CONT**. Pressing the heating **MODE** button scrolls round these modes in sequence, and the display indicates which mode is currently active.

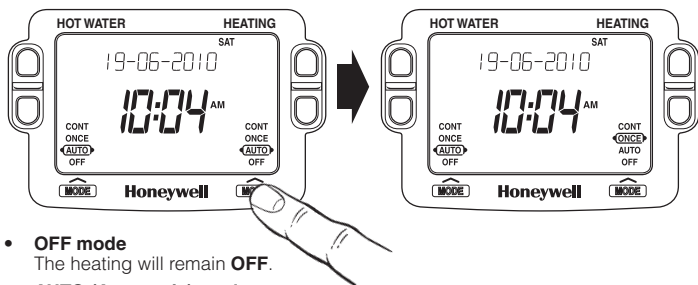





- **OFF mode**
The heating will remain **OFF**.
- **AUTO (Automatic) mode**
The heating will be switched **ON** and **OFF** according to the heating programme.
- **ONCE mode**
The heating will come **ON** at the first programmed **ON** time, and go **OFF** at the last programmed **OFF** time.
- **CONT (Continuous) mode**
The heating will remain **ON** continuously.

The hot water **MODE** button operates in the same way as described above for the heating **MODE** button.

Overriding the Operation Without Changing the Programmes

In **AUTO** and **ONCE** operating modes, the **OVERRIDE** buttons switch the heating or hot water **ON** or **OFF** without altering the programme.

When the  or  symbol is displayed, pressing the **OVERRIDE** button switches the heating or hot water **OFF** until the next programmed **ON** time.



If the  or  symbol is not displayed, pressing the **OVERRIDE** button switches the heating or hot water **ON** until the next programmed **OFF** time.

The LoT™ Display will provide you with information about the override.

The Extra Hour Function (for Heating and/or Hot Water)

The **EXTRA HOUR** buttons allow you to switch the heating or hot water **ON** for up to 3 extra hours without altering the programme. Pressing either button once will give one extra hour. The LoT™ Display will display the message '+1HR', to confirm the button has been pressed.

When the heating or hot water are **OFF** (the  or  symbols are not displayed), pressing an **EXTRA HOUR** button switches the heating or hot water **ON** for just one hour.

When the heating or hot water are **ON** (the  or  symbols are displayed), pressing an **EXTRA HOUR** button extends the programmed **ON** period by one hour.

Further presses of the **EXTRA HOUR** buttons will increase the extra hour period by one hour for each button press, up to a maximum of 3 hours. The LoT™ Display will continue to provide information on the extra hour status.



To cancel the extra hours, just keep pressing the **EXTRA HOUR** button until the 'CANCELLED' message appears on the LoT™ Display.

The Holiday Function

The Holiday function allows you to switch off your heating and hot water for a specified number of days (from 1-99 days). This lets you save energy and related costs when you are away from home, but resumes normal operation on the day of your return.

During this period heating will operate at the **OFF** (frost protection) set temperature and the hot water will remain off.

To set the Holiday function:

- Ensure the slider is in the **RUN** position, then press the **HOLIDAY** button once. The message 'SET HOLIDAY' will appear briefly, followed by 'SET DAYS AWAY'.
- Use the  or  buttons to set the number of days you will be away. The display will show the number of days, and this number will be flashing to indicate it can be changed. The day of the week will also keep changing to show the day you return.
- If you have made a change to the number of days, the message 'DAYS AWAY OK ?' will appear. Press the green  button to confirm your selection.
- The message 'SAVED' will be displayed for a few seconds, followed by the date you return, to enable you to check you have programmed the holiday function correctly.
- During the holiday period, the LoT™ Display will show the message 'ON HOLIDAY' and the display will count down the number of days till you return.

To cancel the Holiday function:

- To cancel the Holiday function, just press the **HOLIDAY** button again. The LoT™ Display will show 'CANCELLED' and the unit will return to normal operation.

Note: while setting the Holiday function, if there is a gap of more than 1 minute between button presses, the function will cancel itself automatically and return to normal operation.

Enquiry Mode

As the heart of your system, the ST9420C has access to temperature information from the other system components, and allows you to enquire about this information.

To enter Enquiry Mode, ensure the slider is in the RUN position, then press and hold the **OK button for 4 seconds.**

The *LoT™ Display* will show the message 'INFO MENU' to confirm that you have entered Enquiry Mode.

Pressing the **⊖** or **⊕** buttons then allows you to step around and view the available information. The *LoT™ Display* will continue to update to tell you what information is being viewed, and the main display will show the value. If the information is not available, the display will show dashes -- -- instead of a temperature value. The table below shows the type and sequence of information available in Enquiry Mode.

To exit Enquiry Mode:

If the **OK** button is not pressed for 30 seconds, your ST9420C will return to **RUN** mode.



Information	LoT™ Message	Other display symbols
* Room temperature	ROOM TEMP	▣▣▣
* Room temperature setting	ROOM SET	▣▣▣
‡ Hot water temperature	WATER TEMP	‡
‡ Hot water temperature setting	WATER SET	‡

* This information will be available if you have a room temperature control system, with a DT92E room thermostat.

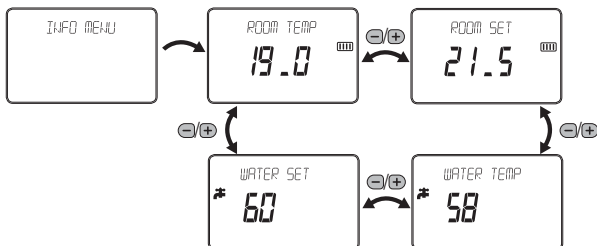
‡ This information will be available if you have a hot water control system, with a CS92A hot water thermostat.



Changing from AM/PM Time Display to the 24 Hour Clock

Your ST9420C can operate on the 12 hour AM/PM or 24 hour clock formats. To change the format, ensure the slider is in the **RUN** position then press and hold the  and  buttons together for about 2 seconds. Ignore the 'NOT VALID' message that will appear briefly. Then the displayed times will be changed automatically to the new format.

Repeating this procedure will change the clock display back to the original format.

Changing the Installer Parameters

The ST9420C has a special Installer Mode where some features can be adjusted to suit your lifestyle or preferences – these are called Installer Parameters, and are listed in the table below, along with a description of the options that are possible.

Your installer should set this up for you to suit your application (see CONFIGURATION & SERVICE DATA section). However, you may wish to alter some of the settings yourself, and this section shows you how to do this.

Note: some parameters indicated by * may only be viewed if the previous parameter is set to a particular value.

INSTALLER PARAMETER	Parameter Number	Default Value	Options	Description
24hr or am/pm clock display.	1	12	12, 24	12 = am/pm display 24 = 24hr display
Configure backlight operation.	2	2	0, 1, 2	0 = off 1 = on if button pressed 2 = on continuously
Enable/disable auto time change.	3	1	0, 1	0 = disabled 1 = enabled
1-day or 5/2-day or 7-day operation.	4	7	1, 5, 7	1 = 1-day operation 5 = 5/2-day operation 7 = 7-day operation
Number of ON/OFFs per day.	5	3	2, 3	2 = 2 on/offs per day 3 = 3 on/offs per day
Select default time programme.	6	A	A, b, C	A = standard b = at home C = economy
Set hot water temperature	8	60°C	40 to 85°C	Stored hot water set temperature

FINE TUNING YOUR ST9420C

INSTALLER PARAMETER	Parameter Number	Default Value	Options	Description
Optimum start	9	0	0, 1, 2	0 = no optimum start 1 = delayed start 2 = optimum start on
* Optimum start limit	10	1	1, 2, 3	1 = 1 hour 2 = 2 hours 3 = 3 hours
Optimum stop	11	0	0, 1	0 = disabled 1 = enabled
Frost protection temperature	12	5	5 to 16°C	Frost protection temperature
Minimum ON/OFF time	13	1	1, 2, 3, 4, 5 mins	Minimum ON/OFF time in minutes
Cycle rate	14	6	3, 6, 9, 12	Number of boiler cycles per hour
Proportional band width	15	1.5	1.5 to 3.0°C	Width of control proportional band in °C
Failsafe mode (loss of RF communications)	16	0	0, 1	0 = off 1 = heating on 20%
Reset all parameters	20	1	0, 1	0 = do not reset 1 = default parameters

To Enter Installer Mode:

- Ensure the slider is in the **RUN** position, then press and hold **OK** and **−** buttons together for 8 seconds. Ignore the 'NOT VALID' message that is displayed for a few seconds. The message 'SET UP MENU' will show briefly, followed by 'SET INSTALLER OK ?'
- Press the **OK** button to take you into the Installer Mode Parameter Menu.
- Parameter 1 is now available to change. This is to allow you to change the clock format from 12 hour AM/PM to 24 hour. At every step, the LoT™ Display will inform you what the parameter means and what option you have selected. The parameter number is shown on the display separated by a colon from the parameter value.
- You can change the parameter value by pressing the **⊖** or **⊕** buttons. At this point the description in the LoT™ Display will change and the parameter value will flash. If you press **OK** the value will stop flashing and be saved for use.

- e. Press **OK** to move to the next parameter available for editing.
- f. Keep pressing **OK** to step around the list of parameters, and use **⬅** **➡** or **+** buttons to change the parameter value.
- g. Any parameter changes that have been confirmed with the **OK** button will be saved and used.

To Exit Installer Mode:

- h. You can exit Installer Mode at any time by moving the slider to the next position and then back again to **RUN**.

Note: Installer Mode will exit automatically after 10 minutes if the slider is not moved.

Optimisation

The Optimisation features are explained on page 5. Parameters 9, 10, and 11 are used to enable or disable and set these features to suit your requirements. You can set Optimum Start, Delayed Start, or Optimum Stop, and you can also set a limit to the Optimum Start time of 1, 2, or 3 hours.

Note: the radiator symbol  will flash to indicate Optimisation is taking place.

The diagrams below illustrate how Optimisation works.

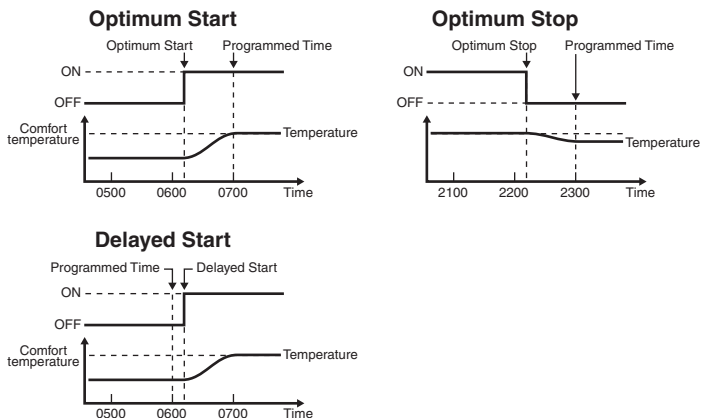

FINE TUNING YOUR ST9420C

How to set your Hot Water Set Temperature

If your system includes a CS92A hot water sensor on your hot water storage tank, you will be able to set the hot water temperature you require at the ST9420C programmer. The temperature is set to 60°C at the factory, but can be set anywhere between 40°C and 85°C, depending on the application. The setting is changed by entering Installer Mode and modifying parameter number 8 to give the required set temperature.

BOILER SERVICE REMINDER

If your house is rented, by Law, your gas boiler should be inspected once a year to ensure it is operating safely. Your ST9420C Programmer has a range of features designed to help make sure this service is carried out at the correct time. These features will be programmed by your Installer, Maintenance Engineer, or Landlord.

- If it has been set to do so, ST9420C will display a message on the screen to remind you that a boiler service is due.
- If the service is overdue, the Programmer may switch off the heating system, to ensure your safety. If this happens you must arrange an immediate service visit. Contact details should be listed on page 35 of this guide, in the section Boiler & System Service Log.
- A contact telephone number may also have been programmed into the ST9420C. If so, a message will appear on the LoT™ Display indicating the number you should call.

Countdown to Service

Your ST9420C can indicate a countdown for the number of days until your service is due. This message will appear on the screen every few seconds, to give you an opportunity to schedule a service visit.

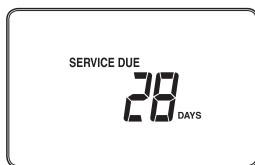

When Service is Due

When your boiler service is **OVERDUE** the words "SERVICE DUE" will continue to flash on your screen, and you should arrange an immediate service visit.

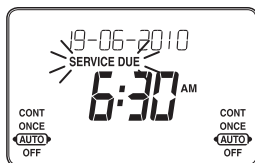

BOILER SERVICE REMINDER

Shut-down

If your ST9420C shows the words “**SERVICE DUE**” and “**OFF**” then your boiler service is **overdue** and the boiler has been automatically switched off to ensure your safety – you should arrange an immediate service visit.

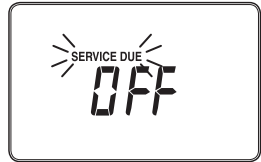

If set to do so, it may be possible to obtain limited use of the boiler by pressing any **EXTRA HOUR** button. Each button press will allow operation of the boiler for 1 hour at a time, and the screen will display the message “**On 1h**” as shown. However, you should still arrange an immediate service visit, as this will allow you to comply with the law and ensure your gas boiler is operating safely.

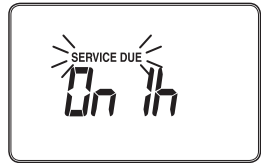

OPERATING YOUR DT92E

Inquiring about the Set Temperature

DT92E normally displays the measured room temperature.

To inquire about the set temperature, simply press one of the ▲ or ▼ buttons. The set temperature will be shown on the display along with the arrow symbols, and the temperature will be flashing.

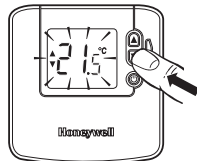

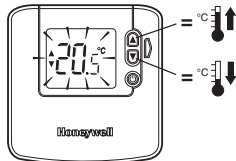
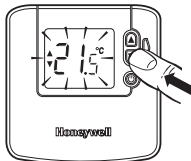

Adjusting the Set Temperature

The set temperature is adjusted by pressing the ▲ or ▼ buttons. Each time one of the buttons is pressed, the set temperature will change by 0.5°C.



OPERATING YOUR DT92E

Switching Off

Pressing the off/standby button  will switch the DT92E into off/standby mode. The  symbol will show in the display, and the unit will control at the frost protect setpoint, as set at the ST9420C.

To switch back on, simply press the  button again.

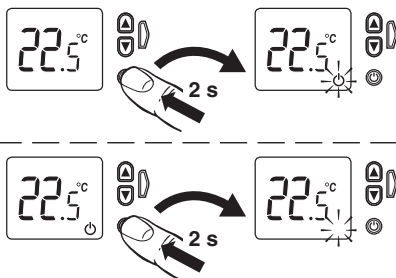

Display Updates

To conserve battery power, DT92E only communicates with ST9420C at regular intervals or when you press a button. This means there can be up to a few minutes delay between an action initiated on ST9420C and the DT92E display being updated.

If you press a button on DT92E it may take a few seconds for ST9420C to respond. DT92E will indicate it is waiting for information by displaying the hourglass symbol and dashes as shown.

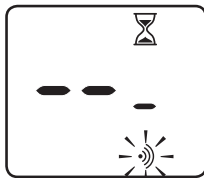

Heating Indicator

The flame symbol indicates that the boiler is on for heating. The flame will disappear when there is no heating demand.

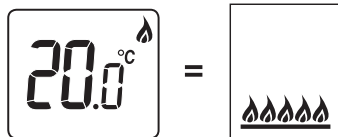

Frost Protection

The frost symbol will be displayed if the room temperature goes below the frost setting. The flame will also be displayed to indicate when the boiler has been switched on.



Low Battery Indicator / Battery Replacement

The battery symbol will start to flash if the battery power is running low. From this point, there will be a minimum of 4 weeks before the product will cease to function.

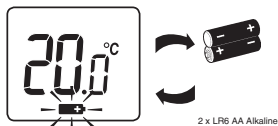

Batteries are accessed by unclipping the front cover at the bottom. Note battery polarity. Reverse process to refit front cover.

Use 2xLR6 (AA) alkaline batteries only.

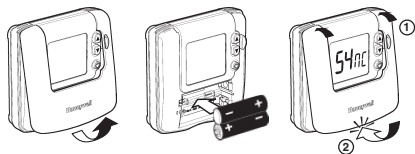

Immediately on power up, DT92E will try to communicate and synchronise with ST9420C. This process may take up to 4 minutes, and will be indicated by the word '**Sync**' on the DT92E display.

RF Communications Indicator

A brief flash of the RF symbol  indicates the DT92E has been communicating with the other system controls.

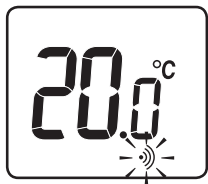

Lockout

Your DT92E works in conjunction with the ST9420C time control. If the timer is set to OFF or CONT it may not be possible to override it from the thermostat and this is indicated by the lockout symbol . To switch the heating on you must go to the timer and set the Mode to AUTO, ONCE, or CONT.

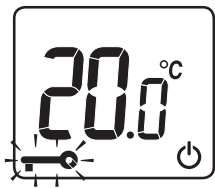

DT92E ENERGY SAVING ECO FEATURE

The ECO button allows you to change to a lower, energy saving set temperature for a period of your choice, from 1 to 24 hours. This temperature is pre-set in the DT92E Installer Mode, but you can adjust this to any temperature you want when ECO mode has been activated. The default ECO temperature is 18°C.

At the end of the time period, the thermostat will return to its original set temperature.

Entering ECO Mode and Setting the Energy Saving Time Period

Press the green ECO button to enter ECO mode. The word ECO will appear on the display and the thermostat will allow you to set the number of hours you want to be at the new set temperature.

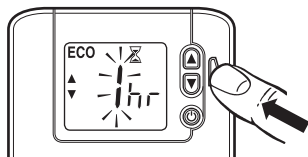

Use the ▲ and ▼ buttons to set the hours, up to a maximum of 24 hours.

Please note – ECO mode is not accessible in Holiday mode or if Service shutdown has occurred.

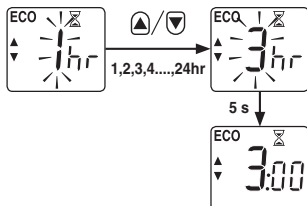

What Happens in ECO Mode?

In ECO mode, the display will show a countdown of the remaining time (hours and minutes) in ECO mode, identified by the hourglass symbol. The display will alternate every 5 seconds to show the current room temperature.

When in ECO mode, pressing the ▲ or ▼ buttons will adjust the set temperature for the remainder of the ECO time period.

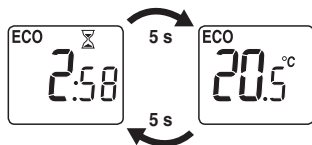

How to Exit ECO Mode

To exit ECO mode, simply press the green ECO button again. ECO will disappear from the display and the thermostat will control to its previous set temperature.

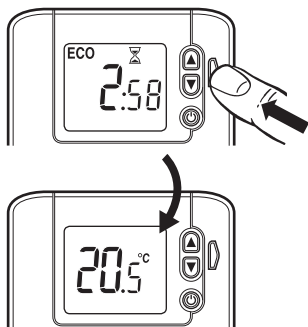

Changing the DT92E Installer Parameters

The DT92E has a special Installer Mode where some features can be adjusted to suit your lifestyle or preferences – these are called Installer Parameters, and are listed in the table below, along with a description of the options that are possible.

Your installer should set this up for you to suit your application (see CONFIGURATION & SERVICE DATA section). However, you may wish to alter some of the settings yourself, and this section shows you how to do this.

INSTALLER PARAMETER	Parameter	Default Value	Options	Description
Temperature measurement offset	t0	0	-3 to 3 K	Offset to measured temperature
Upper setpoint limit	uL	35	21 to 35°C	Upper set temperature limit in °C
Lower setpoint limit	LL	5	5 to 21°C	Lower set temperature limit in °C
Energy saving ECO setpoint	ES	18	5 to 35°C	Energy saving ECO set temperature in °C
Reset parameters to factory settings	FS	1	0, 1	Parameter will be set to 0 if any of the other parameter values have been changed. Set to 1 to get back to factory settings.

FINE TUNING YOUR DT92E

To Enter Installer Mode:

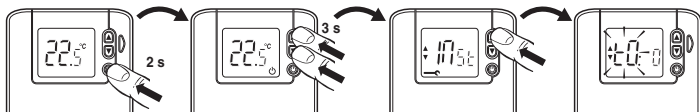

- Hold the button for 2 seconds until DT92E is in standby mode.
- Hold and buttons for 3 seconds until the word '**Inst**' appears on the display.
- Press the button.

The first parameter is now ready to be changed.

To Select a Parameter:

Use the and buttons to move from one parameter to the next. Stop at the Parameter you wish to change.

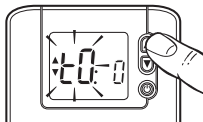

To Change a Parameter:

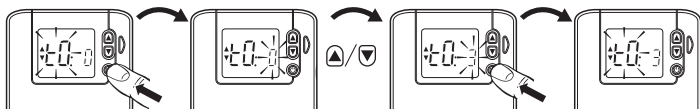

Use the standby button to select the parameter value, then the and buttons to change the value. Confirm the change by pressing the button again to take you back to the parameter.

To Exit Installer Mode:

Hold the button for 3 seconds to exit Installer Mode.

Note: The Installer Mode will exit automatically after 10 minutes if no adjustments have been made in this time.

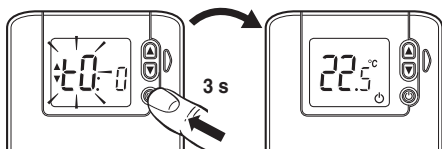

OPERATING YOUR CS92A HOT WATER THERMOSTAT

Basic Operation

Your CS92A consists of a sensor element that is strapped to the metal surface of the hot water cylinder and a wireless transceiver box that is normally mounted on a wall surface apart from the cylinder. The transceiver communicates with the ST9420C programmer and regularly sends the hot water temperature measurement to it.

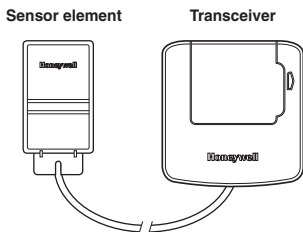

Battery Replacement

The CS92A batteries should last for a minimum of 2 years. Well before they run out, CS92A will communicate with ST9420C and it will show the message 'SENSOR LOW BATT' whilst also flashing the tap symbol.

Batteries are accessed by unclipping the front cover at the bottom. Note battery polarity. Reverse process to refit front cover.

Use 2xLR6 (AA) alkaline batteries only.

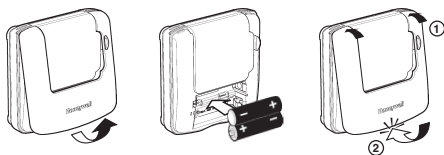

Error Indications

To save battery power, CS92A will indicate error conditions on the LoT™ Display of ST9420C. It is possible to view the CS92A status by pressing the button on the transceiver box. The lights underneath this button will provide feedback as shown in the table. Go to the FAQ AND TROUBLESHOOTING section for more information.

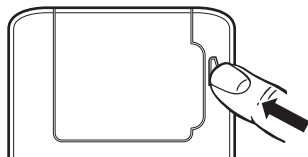

Green Light	Red Light	Status
On	Flashes up to 5 times in succession, then repeats	Everything is OK, red light shows signal strength - press button again to exit
Off	Flashes 0.1 s on, 0.9 s off	Battery low condition, replace batteries
Off	Flashes 0.5 s on, 0.5 s off	Sensor error, check sensor connection
Off	On continuously	Loss of communications

OPERATING YOUR BDR91T RELAY BOX (IF INSTALLED)

BDR91T Controls Layout

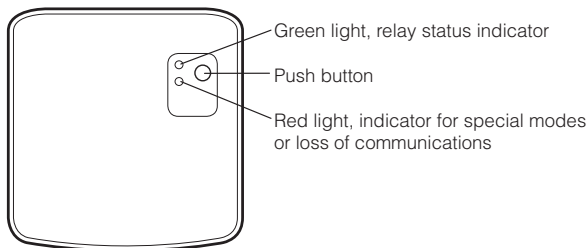

Automatic Operation

The BDR91T relay box simply switches the boiler on and off according to a wireless signal it receives from the ST9420C. It is mainly used when the boiler is installed in a remote location where it may be difficult to run wires direct from the timer. The green light indicates the status of the relay output:

Green light on = relay on

Green light off = relay off

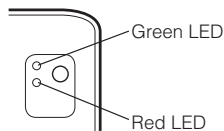

Temporary Manual Override

In normal operation it should not be necessary to interact with the BDR91T. However it is possible to press the button and temporarily override the current relay position. This will be cancelled as soon as the Relay Box receives another signal from the ST9420C, because automatic operation has a higher priority than manual operation.

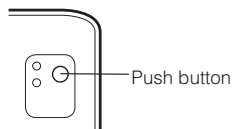

Loss of Wireless Communications

If the RF communication is lost for a period of 1 hour the red light will illuminate.

The Relay Box will then enter the failsafe mode as selected by your Installer (see page 34).

When RF communication is restored, the Relay Box will automatically return to normal operation.

How do I set the time only, if the ST9420C clock is not correct?

Your ST9420C contains an accurate digital clock that is factory set. Should you ever need to change the time, just follow this procedure:

- a. Move the slider to the **DAY/TIME** position.
- b. Keep pressing the green **OK** button until the message 'SET THE TIME' is displayed. To change the time, press the **⏪** or **⏩** buttons until the correct time is shown. The message 'IS TIME OK?' will be displayed. Press the green **OK** button to confirm the time is correct. If you have made a change, the message 'TIME SAVED' will show, followed quickly by 'DATE + TIME COMPLETE'.
- c. Move the slider to the **RUN** position, to complete changing the time.

What do I do when the clocks go back in October and forward in March?

Your ST9420C is factory set to change the clock automatically at the correct dates, so you should never need to adjust the clock forward or backwards yourself. It is possible to disable this particular feature, as described in the section '**Changing the Installer Parameters**' (page 15). You may also check the section '**Configuration & Service Data**' (page 34) to see how your Installer has configured your product.

What should I do if I get 'lost' while programming the ST9420C?

The LoT™ Display on ST9420C will provide you with help and tips to work through the programming. Should you ever get 'lost', the simplest thing to do is to move the slider to the **RUN** position, and then move it back to the appropriate programming position where you got lost. At this point just follow the instructions again.

What happens if there is a power failure?

In the event of a mains power failure, the ST9420C display will go blank, the indicator lamps will go out, and the control outputs will switch off. The real time will be constantly maintained by means of the built-in battery backup, ready to power back up as if nothing had happened when the mains power is restored. In addition, all programmes and settings are stored in a special memory (called Non Volatile memory) which requires no power to maintain information so will be retained indefinitely.

Should the correct time and date ever be lost, for whatever reason, the message 'SET DATE + TIME' will be displayed whilst the slider is in the **RUN** position. In this case, simply follow the procedure described under '**Step 1: Setting the Date & Time**' (page 6). It should not be necessary to make any changes to your programmes.

How reliable is 2-way RF communication?

The 2-way RF communication (also known as wireless communication) used by Honeywell is extremely robust and reliable. When installed correctly the Signal Strength test feature allows the Installer to locate the system components where mutual signal reception is strong. During communication, signals are sent several times to ensure receipt, and if any message is garbled, the error detection software recognises this and ensures the message is repeated again.

What do I do if RF communication is lost?

Follow the steps in the Troubleshooting Guide on the next page. The most likely cause for loss of communications is the DT92E batteries running low on power. This will be indicated on the DT92E display by a flashing battery symbol, or the display may even be blank. Simply replace the batteries (as shown on page 21) and wait a few minutes for communications to become re-established.

If this does not resolve the problem it may be that the RF signal path between the ST9420C and the DT92E is blocked by a metal object. Check the direct path between the two devices and reposition any object that may be blocking the signal, or move the thermostat.

How do I know when to change the batteries in the CS92A cylinder sensor?

If the CS92A batteries need changing, the ST9420C will show the message "SENSOR LOW BATT" and the tap symbol  will flash. You can confirm this by pressing the CS92A button, whereupon the red light will give a brief flash every second to indicate a low battery state. It is important to change the CS92A batteries as soon as the low battery condition is indicated, as reduced battery power may affect the RF signal strength and impair RF communications.

How do I know when to change the batteries in the DT92E room thermostat?



If the DT92E batteries need changing, the battery symbol will flash on the DT92E display. DT92E will continue to operate for at least 4 weeks after the indicator begins to flash. The ST9420C will also show the message 'SENSOR LOW BATT' and the radiator symbol  will flash. It is important to change the DT92E batteries as soon as the low battery condition is indicated, as reduced battery power may affect the RF signal strength and impair RF communications.

Can I override the Programmer from the DT92E thermostat?





As well as changing the set temperature from the DT92E, it is also possible to override the heating system on or off from the DT92E. This is only possible if the ST9420C is in AUTO or ONCE Modes. If ST9420C is in CONT mode it will not be possible to switch the heating off from the DT92E. Similarly, if ST9420C is in OFF mode, it will not be possible to switch the heating on from the DT92E. If these latter overrides are required it is first necessary to change the ST9420C mode setting to AUTO or ONCE.

Troubleshooting Guide







This is a quick guide to help you diagnose and cope with possible problems with your wireless control system. For further assistance, please contact your Installer.

Symptom	Possible Cause	Remedy
ST9420C has a blank LCD display	No power to the heating system.	Check that there is power to the heating system.
	Fault in ST9420C	Call Installer
ST9420C indicates that Heating and/or Hot Water are ON , but radiators are cold and/or taps are running with cold water.	Temperature controls are switched off or set too low.	Check that the temperature controls in the system are set to appropriate levels.
	Boiler or other system controls have malfunctioned.	Call Installer
ST9420C shows the message: 'INTERNAL FAULT'	Fault in ST9420C	Call Installer
Every few seconds, the ST9420C screen shows the message: 	ST9420C is counting down the number of days until your next boiler service is due.	Arrange a boiler service before the counter reaches zero. After servicing your boiler, the Service Engineer / Installer will reset the ST9420C to remind you when the next boiler service is due. Each service is normally a maximum of 1 year apart.
Although the heating is still operating, the ST9420C screen keeps flashing the message: 	Your boiler service is overdue .	Arrange an immediate boiler service. After servicing your boiler, the Service Engineer / Installer will reset the ST9420C to remind you when the next boiler service is due. Each service is normally a maximum of 1 year apart.

FAQ AND TROUBLESHOOTING

Symptom	Possible Cause	Remedy
<p>The ST9420C screen shows the message:</p> 	<p>Your boiler service is overdue and the boiler has been automatically switched off to ensure your safety.</p>	<p>Arrange an immediate boiler service.</p> <p>If set to do so, it may be possible to obtain limited use of the boiler by pressing any EXTRA HOUR button. Each button press will allow operation of the boiler for 1 hour at a time, and the screen will display the message 'On 1h'.</p> <p>After servicing your boiler, the Service Engineer / Installer will reset the ST9420C to remind you when the next boiler service is due. Each service is normally a maximum of 1 year apart.</p>
<p>ST9420C shows the message 'SENSOR LOW BATT' and a flashing radiator symbol </p>	<p>Your DT92E batteries are running low on power.</p>	<p>Change the DT92E batteries (see page 21 for how to do this).</p>
<p>DT92E shows a flashing battery symbol </p>		
<p>DT92E display is blank</p>		
<p>ST9420C shows the message 'SENSOR LOW BATT' and a flashing tap symbol </p>	<p>Your CS92A batteries are running low on power.</p>	<p>Change the CS92A batteries. This is located next to your hot water storage tank (see page 25 for a description of how to change the batteries).</p>
<p>CS92A battery low indication (press CS92A button and red light gives a short flash every second 0.1s on, 0.9s off. Note: light will switch off after approx 1 minute to save battery power).</p>		

FAQ AND TROUBLESHOOTING

Symptom	Possible Cause	Remedy
<p>ST9420C shows the message 'NO SIGNAL' and a flashing radiator symbol </p> <p>DT92E shows a flashing RF symbol </p>	<p>Your DT92E batteries are running low on power.</p>	<p>Change the DT92E batteries (see page 21 for how to do this).</p>
	<p>RF communication path between ST9420C and DT92E is blocked, possibly by a metal object.</p>	<p>Check direct path between both products and re-position any objects that may be blocking the signal.</p> <p>Relocate the DT92E, if possible.</p>
<p>ST9420C shows the message 'NO SIGNAL' and a flashing tap symbol </p> <p>CS92A communications failure indication (Press CS92A button and red light comes on. Note – light will switch off after approx 1 minute to save battery power).</p>	<p>Your CS92A batteries are running low on power.</p>	<p>Change the CS92A batteries. This is located next to your hot water storage tank (see page 25 for description of how to change the batteries).</p>
	<p>RF communication path between ST9420C and CS92A is blocked, possibly by a metal object.</p>	<p>Check direct path between both products and re-position any objects that may be blocking the signal.</p>
<p>ST9420C shows the message 'NO SIGNAL' and a flashing flame symbol </p> <p>Red light on BDR91T (if installed) is lit continuously.</p>	<p>RF communication path between ST9420C and BDR91T is blocked, possibly by a metal object</p>	<p>Check direct path between both products and re-position any objects that may be blocking the signal</p>
<p>ST9420C shows the message 'SENSOR FAULT' and a flashing radiator symbol </p> <p>DT92E display shows '- - -' and a flashing spanner symbol </p>	<p>Fault with DT92E</p>	<p>Call Installer</p>

FAQ AND TROUBLESHOOTING

Symptom	Possible Cause	Remedy
ST9420C shows the message 'SENSOR FAULT' and a flashing tap symbol 	CS92A sensor cable may be disconnected from the wiring terminals.	Re-connect the sensor wired to the CS92A terminals.
CS92A sensor error indication (Press CS92A button and red light blinks 0.5s on, 0.5s off. Note – light will switch off after approx 1 minute to save battery power).	Fault with CS92A	Call Installer

CONFIGURATION & SERVICE DATA

Application

Insert application number as per Installation wiring diagrams:

Configuration Data (to be completed by Installer)

The tables below are for the Installer to complete to indicate how your ST9420C and DT92E have been configured.

Configurable Features	Options	Factory setting	Installer configured (tick box or note value)
ST9420C Configuration - standard			
24hr or am/pm clock display.	am/pm display	✓	
	24hr display		
Display backlight operation.	Off		
	on if button pressed		
	on continuously	✓	
Automatic time change.	disabled,		
	enabled	✓	
1-day or 5/2-day or 7-day operation.	1-day operation		
	5/2-day operation		
	7-day operation	✓	
Number of ON/OFFs per day.	2 on/off's per day,		
	3 on/off's per day	✓	
Default time programme.	A = standard	✓	
	b = at home		
	C = economy		
Hot water set temperature	From 40 to 85°C	60°C	
Optimum start	no optimum start	✓	
	delayed start		
	optimum start on		
Optimum start limit	1 hour	✓	
	2 hours		
	3 hours		
Optimum stop	disabled	✓	
	enabled		
Frost protection temperature	From 5 to 16°C	5°C	
Minimum ON/OFF time	1, 2, 3, 4, 5 minutes	1 minute	
Cycle rate	3, 6, 9, 12 cycles per hour	6 cycles	
Proportional band width	From 1.5 to 3.0°C	1.5°C	
Failsafe mode (loss of RF communications)	off	✓	
	on 20%		