

NOVA GRANITE SINK

NOV8651BL/



Size: 860 x 500 mm

Nova combines style with functionality; the drainer with defined straight lines creates a contemporary look and larger bowl adds a practical design with room to accommodate large utensils, making it easier to use.

- Reverse drainer
- Compact option,
- Waste kit included
- Hygienic surface
- Anti-impact
- Anti-shock
- Anti-UV

Material	Granite
Material Gauge	
Material Finish Bowl	
Material Finish Drainer	
Drainer Position	Reversible
Overall Length (mm)	860
Overall Width (mm)	500
Main Bowl Length (mm)	330
Main Bowl Width (mm)	425
Main Bowl Depth (mm)	217
Second Bowl Length (mm)	-
Second Bowl Width (mm)	-
Second Bowl Depth (mm)	-
Tap hole Size (mm)	1 x 35
Waste Size (mm)	1 x 90
Waste Kit	Included with sink (1 x 90mm)
Min. Base Unit (mm)	450
Cutout Size Length (mm)	840
Cutout Size Width (mm)	480
Warranty Sinks (years)	10
Product Code	NOV8651BL/
Barcode	5015834055497

Date of download: March 05, 2026

AGA Rangemaster continuously seeks improvements in specification, design and production of products and thus, alterations take place periodically. Whilst every effort is made to produce up-to date resources, the information included here is intended as a guide. Always refer to the product's installation instructions when fitting, installation work should be completed a professional tradesman.

NOVA GRANITE SINK

NOV8651BL/

Technical Drawing

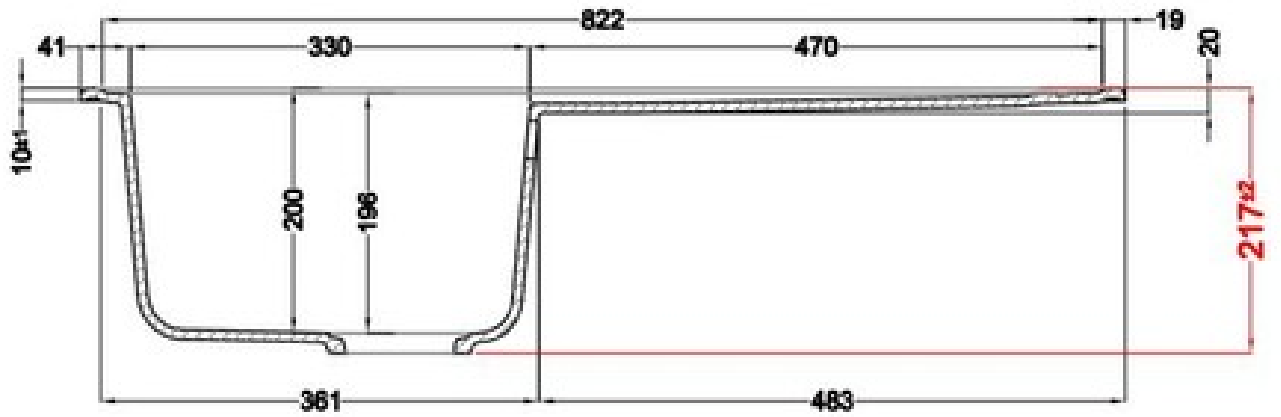
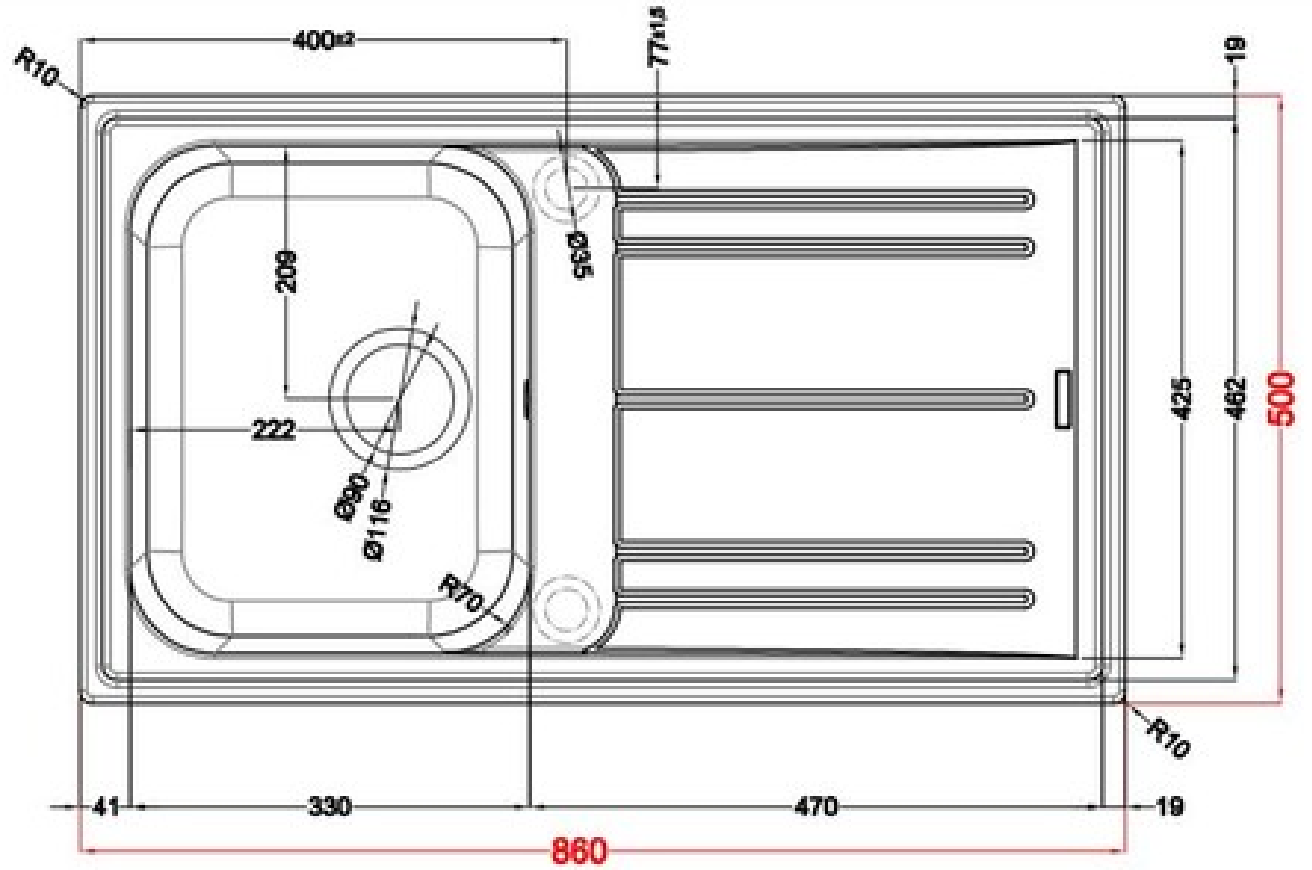
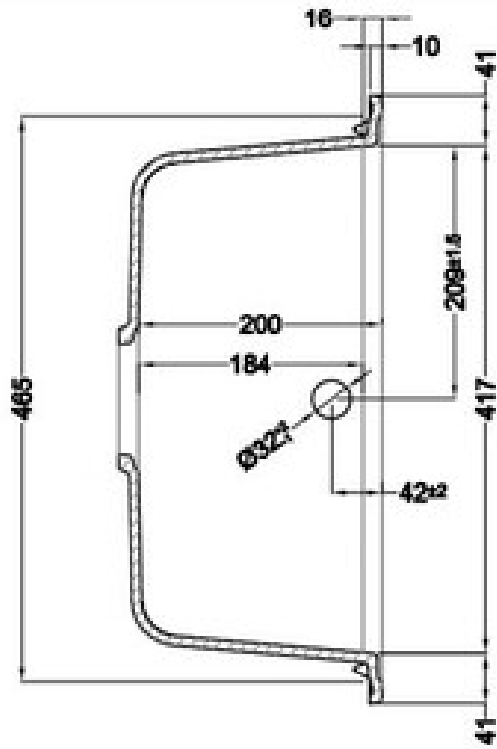

Date of download: March 05, 2026

AGA Rangemaster continuously seeks improvements in specification, design and production of products and thus, alterations take place periodically. Whilst every effort is made to produce up-to date resources, the information included here is intended as a guide. Always refer to the product's installation instructions when fitting, installation work should be completed a professional tradesman.

NOVA GRANITE SINK

NOV8651BL/