

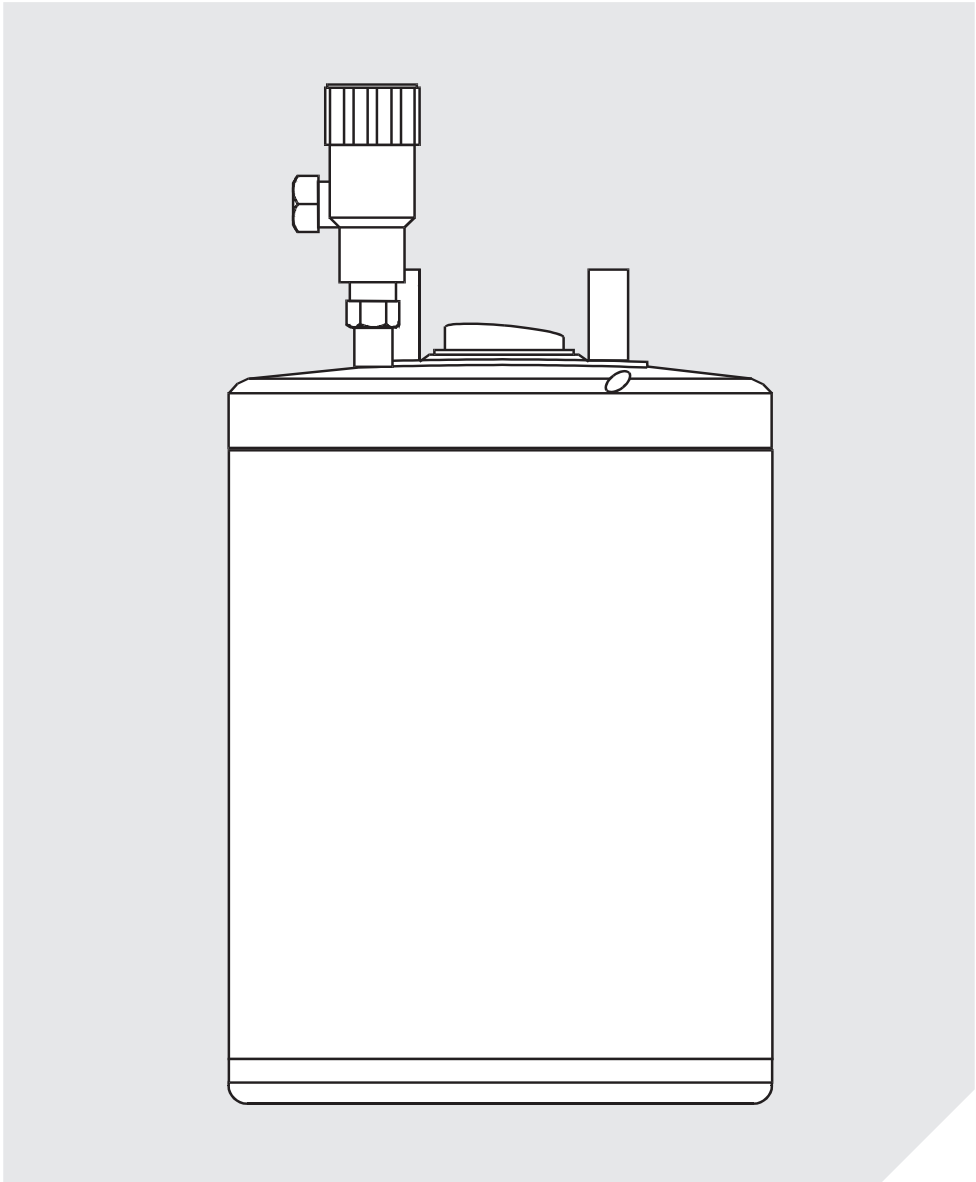

HEATRAESADIA

SMARTER | CLEANER | WARMER

Multipoint 10 and 15 litre Fitting Instructions





Contents

1. Introduction	3	6. Installation	8
1.1 General	3	6.1 General	8
1.2 Symbols used.....	3	6.2 Water connections.....	8
1.3 Abbreviations.....	3	6.3 Electrical connections	9
1.4 Liabilities	3	7. Commissioning	10
2. Safety	4	7.1 General	10
2.1 General safety warnings	4	7.2 Checklist before commissioning.....	10
2.2 Recommendations	4	7.3 Commissioning procedure	10
2.3 Specific safety instructions.....	4	8. Operation	11
3. Technical specification	5	8.1 General	11
3.1 Technical data	5	9. Maintenance	12
3.2 Dimensions and connections	5	9.1 General	12
3.3 Electrical diagram(s)	5	9.2 Standard inspection & maintenance operations	12
4. Description of the product	6	10. Troubleshooting	13
4.1 General description	6	10.1 Fault finding.....	13
4.2 Operation principle	6	11. Decommissioning procedure	14
4.3 Standard delivery	6	12. Spare parts	14
4.4 Mains connections	6	Accessories	15
5. Before installation	7	Warranty	15
5.1 Installation regulations	7		
5.2 Installation requirements	7		
5.3 Choice of location.....	7		



The HWA Charter Statement requires that all members adhere to the following:

- ▶ To supply fit for purpose products clearly and honestly described.
- ▶ To supply products that meet, or exceed appropriate standards and building and water regulations.
- ▶ To provide pre and post sales technical support.
- ▶ To provide clear and concise warranty details to customers.



This product can be used by children aged from 8 years and above and persons with reduced physical sensory or mental capabilities or lack of experience and knowledge if they have been given supervision or instruction concerning use of the product in a safe way and understand the hazards involved. Children shall not play with the product. Cleaning and user maintenance shall not be made by children without supervision. Children must be supervised to ensure they do not play with the product.



1. Introduction

1.1 General

The following instructions are offered as a guide to the user and installer.

The installation must be carried out by a competent plumbing and electrical installer in accordance with Building Regulation G3 (England and Wales), Technical Standard P3 (Scotland) or Building Regulation P5 (Northern Ireland) and the Water Fitting Regulations (England and Wales) or Water Byelaws (Scotland).

1.2 Symbols used

In these instructions, various risk levels are employed to draw the user's attention to particular information. In doing so we wish to safeguard the user, avoid hazards and guarantee the correct operation of the appliance.



DANGER

Risk of dangerous situation causing slight physical injury.



WARNING

Risk of dangerous situation causing slight physical injury.



CAUTION

Risk of material damage.



Signals important information.

1.3 Abbreviations

- ▶ RCD – Residual current device
- ▶ MCB – Miniature circuit breaker

1.4 Liabilities

Manufacturer's liability

Our products are manufactured in compliance with the requirements of the various applicable European Directives.

This product complies with the requirements of the CE marking directive.

In the interest of UK customers, we are continuously endeavouring to make improvements in product quality. All the specifications stated in this document are therefore subject to change without notice.

Our liability as the manufacturer may not be invoked in the following cases:

- ▶ Failure to abide by the instructions on using the product.
- ▶ Faulty or insufficient maintenance of the product.
- ▶ Failure to abide by the instructions on installing the product.

Installer's liability

The installer is responsible for the installation and the commissioning of the product. The installer must respect the following instructions:

- ▶ Read and follow the instructions given in the manuals provided with the product.
- ▶ Carry out installation in compliance with the prevailing legislation and standards.
- ▶ Perform the initial start-up and carry out any checks necessary.
- ▶ Complete the commissioning checklist.
- ▶ Explain the installation to the user.
- ▶ If maintenance is necessary, warn the user of the obligation to check the product and maintain it in good working order.
- ▶ Give the instruction manual to the user.

User's liability

To guarantee optimum operation of the product, the user must respect the following instructions:

- ▶ Read and follow the instructions given in the manuals provided with the product.
- ▶ Call on qualified professionals to carry out installation and initial start-up.
- ▶ Get your fitter to explain your installation to you.
- ▶ Have your required checks and services done.
- ▶ Keep the instruction manuals in good condition and close to the product.

2. Safety

2.1 General safety warnings



DANGER

This product is unvented and as such becomes pressurised when in operation. The combination of pressurisation and hot water could lead to serious physical injury if the safety instructions in this manual are not adhered to.



DANGER

Do not install where the unit may freeze.



WARNING

- ▶ Only competent persons having received adequate training are permitted to work on the product and the installation.
- ▶ Do not tamper with the safety valve supplied.
- ▶ Before any work, switch off the mains supply to the appliance.
- ▶ Do not switch on if there is a possibility that the water in the appliance is frozen.



CAUTION

Do not operate immersion heater until the product has been filled with water.

2.2 Recommendations



CAUTION

- ▶ Annual maintenance is recommended by a competent person.

2.3 Specific safety instructions



WARNING

DO NOT operate the product if:

- ▶ Water ceases to flow during use.
- ▶ Water has entered inside the product because of an incorrectly fitted cover.
- ▶ If the appliance is damaged.

(in all cases turn off mains power and isolate water supply)

- ▶ If water discharges from the temperature/pressure relief valve on the product shut down. Do not turn off any water supply. Contact a competent installer for unvented water heaters to check the system.
- ▶ Do not tamper with any of the safety valves fitted to the system. If a fault is suspected contact a competent installer.
- ▶ DO NOT bypass the thermal cut-out in any circumstance.

3. Technical specification

3.1 Technical data

Electrical rating	3kW@240V~/2.75kW@230V~ 4.5kW@240V~/4.1kW@230V~			
Capacities	10 or 15 litres			
Weight (full)	10 litre - 16.9kg	15 litre - 23.8kg		
Rated pressure	0.6MPa (6 bar)			
Minimum recommended supply pressure	0.08MPa (0.8 bar)			
Maximum supply pressure to PRV	1.6MPa (16.0 bar)			
Temperature/Pressure Relief Valve	90°C/0.7MPa (7 bar)			
Supplier's name or trade mark	Multipoint			
Supplier's model identifier	10L (3kW)	10L (4.5kW)	15L (3kW)	15L (4.5kW)
Storage volume V in litres	10.0	10.0	15.0	15.0
Mixed water at 40°C V40 in litres	15	15	23	23
The declared load profile	XXS	XXS	XXS	XXS
The water heating energy efficiency class of the model	A	A	A	A
The water heating energy efficiency in %	35.4	35.4	35.1	35.1
The annual electricity consumption in kWh	520	520	526	526
Daily fuel consumption in kWh	2.450	2.450	2.480	2.480
The thermostat temperature settings of the water heater, as placed on the market by the supplier	60°C			
Specific precautions that shall be taken when the water heater is assembled, installed or maintained and disposed of at end of life	See Section 3 - 11			

Table: Technical parameters in accordance with European Commission regulations 814/2013 and 812/2013

3.2 Dimensions and connections

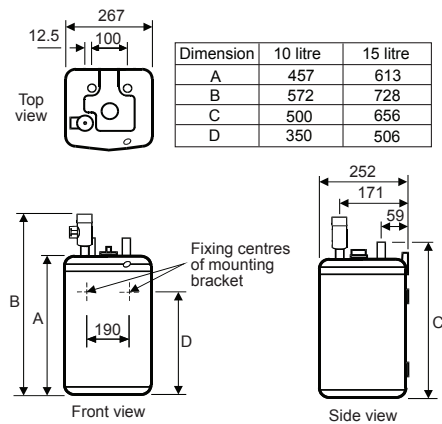

Figure 1

3.3 Electrical diagram(s)

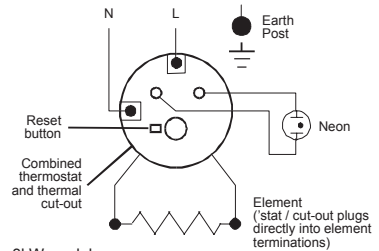

Figure 2 – 3kW model

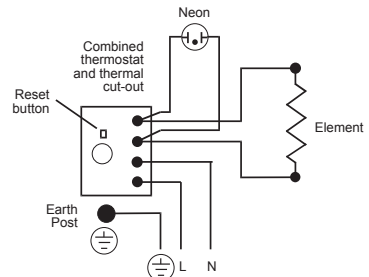

Figure 3 – 4.5kW model

4. Description of the product

4.1 General description

This product is a purposely designed unvented water heater. The product has a copper inner vessel, which ensures an excellent standard of corrosion resistance. The outer casing is a combination of resilient thermoplastic moldings and painted steel.

The product is supplied complete with all the necessary safety and control devices needed to allow connection to the cold water mains. These components are preset and should not be tampered with.

4.2 Operation principle

The product is used to heat and store hot water for use in domestic applications.

4.3 Standard delivery

- ▶ Product
- ▶ Fixing bracket
- ▶ Screw pack
- ▶ Instructions

4.4 Mains connections

See figure 4-6 below.

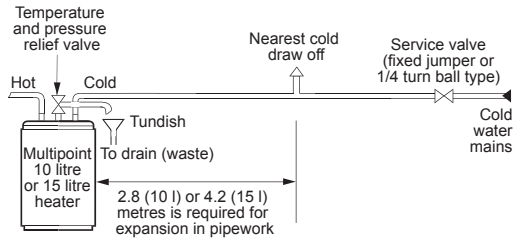

Figure 4 – For inlet pressure up to 0.41 MPa (4.1 bar)

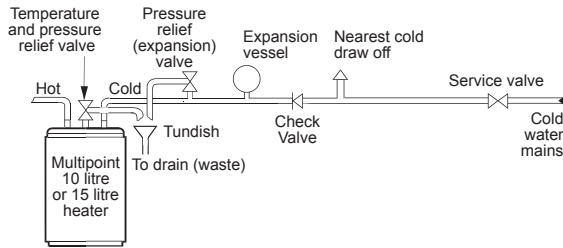
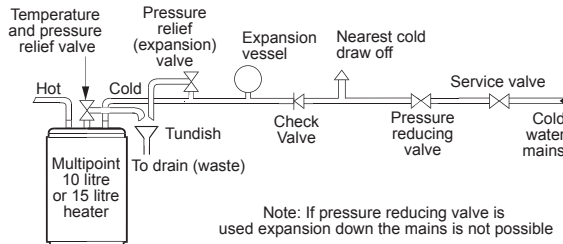

Figure 5 – For inlet pressure up to 0.41 MPa (4.1 bar) where expansion in mains supply is not possible



Note: If pressure reducing valve is used expansion down the mains is not possible

Figure 6 – For inlet pressure above 0.41 MPa (4.1 bar)

5. Before installation

5.1 Installation regulations



WARNING

Installation of the product must be carried out by a qualified engineer in accordance with prevailing and national regulations as listed below.

- ▶ Building Regulations
- ▶ The Building Standards (Scotland)
- ▶ The Building Regulations (Northern Ireland)
- ▶ I.E.E Electrical Regs
- ▶ UK Water Regulations

5.2 Installation requirements

Water supply

In an unvented system the pressure and flowrate is directly related to the incoming water supply. For this reason it is recommended that the maximum water demand is assessed and the water supply checked to ensure this demand can be satisfactorily met.

- ▶ We suggest the minimum supply requirements should be 0.08MPa (0.8 bar) pressure.
- ▶ A 15mm cold water supply is recommended.
- ▶ The higher the available pressure and flow rate the better the system performance.
- ▶ The water supply must be of wholesome water quality (Fluid Category 1 as defined by the Water Supply Regulations 1999).

Outlet/terminal fittings (taps,etc.)

- ▶ The product can be used with most types of terminal fittings.
- ▶ All fittings, pipework and connections must have a rated pressure of at least 8 bar at 80°C.

5.3 Choice of location

- ▶ National Wiring rules may contain restrictions concerning the installation of these products in bathrooms.
- ▶ The product should be vertically wall mounted using the wall bracket supplied. The water connections must always be to the top of the product.
- ▶ Enough space should be left at the top above the product for pipe connections and access to the Temperature/Pressure Relief Valve. Refer to figure 1 and the Dimensions Table to determine a suitable position for the product.



WARNING

Ensure that the wall can support the full weight of the product (see Technical specifications) and that there are no hidden services (electricity, gas, or water) below the surface of the wall.

6. Installation

6.1 General

After reading the previous sections in this booklet and choosing a good location for the product please install, paying attention to the following hydraulic, electrical and commissioning sections.

6.2 Water connections



WARNING

- ▶ Under no circumstances should the factory fitted temperature/pressure relief valve be removed other than a competent person. To do so will invalidate any guarantee or claim.
- ▶ No control or safety valve should be tampered with or used for any other purpose.
- ▶ The discharge pipe should not be blocked or used for any other purpose.
- ▶ The tundish should not be located adjacent to any electrical components.

Refer to the Installation schematic (figure 4-6, page 6) to determine which valves and accessories are required.

Plumb in the valves in the sequence shown in the relevant figures 4-6, page 6.

- ▶ The water connections are 15mm diameter copper tubes suitable for compression fittings. Do not use solder joints as this will damage the heater and may prevent servicing under warranty.
- ▶ The INLET is marked BLUE, the OUTLET is marked RED. The WRAS listed isolating valve (supplied) must be fitted on the cold water supply to the product. Several hot outlets can be served.
- ▶ Plumbers Paste must not be used as it can impair the operation of the valves.
- ▶ The product MUST be fitted with a Pressure Relief Valve. The factory fitted Temperature/Pressure Relief Valve can fulfil this function.



WARNING

Failure to provide adequate pressure relief will invalidate any guarantee and lead to a dangerous installation.

- ▶ Expansion can take place within the cold water supply provided that both :
 - Backflow in the main is not prevented by any stop valve with loose jumper, check valve, pressure reducing valve or similar, and
 - Hot water expansion does not enter a branch to a cold water outlet (see Figure 02 for expansion pipe lengths).Both the above conditions must be met. Additionally expansion within the cold water supply will not be possible if the static supply pressure exceeds 0.41 MPa (4.1bar).
- ▶ If any of the conditions in above cannot be met, expansion must be accommodated using an Expansion Vessel. To ensure all expansion takes place in the vessel a Check Valve must also be fitted together with a Pressure (expansion) Relief Valve (see Figure 03). Use Accessory Pack U2 code no. 95 970 351.
- ▶ If the static supply pressure exceeds 0.41 MPa (4.1 bar) a Pressure Reducing Valve must be fitted to the cold main supply. If a Pressure Reducing Valve is used, an Expansion Vessel must also be used (see Figure 04). Use Accessory Packs U1 and U2 Code No.'s 95 970 352 and 95 970 351.

Discharge

- ▶ The discharge outlet from the Pressure (expansion) Relief Valve and the Temperature/Pressure relief Valve must be connected to a discharge pipe. It is recommended that the tundish supplied be installed in the discharge pipe to give a visible indication that the valves are operating.
- ▶ The discharge pipe must fall continuously from the valve outlets and be unobstructed, and in a frost-free environment.
- ▶ The pipe from the valves to the tundish should be 15mm o/dia minimum. From the tundish to the point of discharge the pipe should be 22mm o/dia minimum and have a resistance to flow equivalent to 9 metres of straight pipe. Long discharge pipe runs should have an increased internal diameter.
- ▶ The water may drip from the discharge pipe of

the pressure relief device and that this pipe must be left open to the atmosphere. The pressure relief device is to be operated regularly to remove lime deposits and to verify that it is not blocked.

- ▶ The pipe material should be capable of conveying water/steam at 100°C.
- ▶ The final discharge point should be in a safe, visible position.

6.3 Electrical connections



WARNING

- ▶ Disconnect from the mains electrical supply before removing any covers.
 - ▶ This product must be earthed. It is suitable for a.c. supply only.
 - ▶ Disconnect the electrical supply before removing the terminal cover.
 - ▶ Installation must be in accordance with the current I.E.E. Wiring Regulations.
- ▶ The product is supplied fitted with a 0.75m 3 core 1.5mm² flexible cable on the 3kW model or a 0.75m 3 core 2.5mm² cable on the 4.5kW model. The electricity supply should be fused 13 Amp for a 3kW model and 20 Amp for a 4.5kW model and be via a double pole isolating switch with a contact separation of at least 3mm in both poles. Refer to the schematic wiring diagrams below.

The wires are colour coded as follows:

Green and Yellow	EARTH
Brown	LIVE (L)
Blue	NEUTRAL (N)



7. Commissioning

7.1 General

After filling the installation with water in the previous section please follow the following steps to complete the installation of the product.



WARNING

DO NOT switch on the product until it has been filled with water.

7.2 Checklist before commissioning

- ▶ Check all water connections for leaks and rectify as necessary.
- ▶ Check that all installation, electrical and discharge pipe requirements have been met.
- ▶ Check that electrical connections are tight.

7.3 Commissioning procedure

- ▶ Open a hot water tap, turn on mains water supply to the product.
- ▶ Allow product to fill and leave hot tap running for a short while to purge any air and flush out the pipework. Close the hot tap and check the system for leaks.
- ▶ Manually test the operation of the Temperature/Pressure Relief Valve and, if fitted, the Pressure (expansion) Relief Valve. Ensure water flows freely from the valve(s) and through the discharge pipes.
- ▶ Switch on the electrical supply. The indicator light will illuminate during heating. When the set temperature is reached, the indicator light will go out.
- ▶ The set temperature can be adjusted by rotating the knob located in the terminal cover. It is possible to lock the thermostat knob in either the mid-range or a "hot" position by following the procedures. Always switch off the electrical supply before removing the terminal cover.

- ▶ Setting the "mid-range" position:
Rotate the thermostat knob to the mid position. Remove the terminal cover by using a large flat bladed screwdriver to depress the three snap lugs located in the three top rectangular depressions. Holding the thermostat knob in position turn the terminal cover over and remove the backing disc from the underside of the cover. Turn the backing disc over and refit to the knob ensuring the notch locates with the boss on the underside of the cover. Refit the terminal cover, the thermostat will now be locked in the "mid-range" position.
- ▶ Setting the "hot" position:
Rotate the thermostat knob to mid way through the hot graduated range (red graphic). Follow the procedure detailed above, however in this case the knob should be held in the "hot" position previously set. When the terminal cover has been refitted the thermostat will be locked in the "hot" position. This position is recommended when using the heater in conjunction with a thermostatic blending valve.
- ▶ Water may drip from the discharge pipe of the pressure relief device - this pipe must be left open to atmosphere.



8. Operation

8.1 General



WARNING

- ▶ Do not block or restrict the discharge from any safety valve fitted.
- ▶ Do not tamper with any safety valve fitted.
- ▶ If water discharges from any safety valve fitted, switch off the electrical supply to the product immediately. Contact the Heatrae Sadia Service Team (Tel: 0844 8711535) or an approved installer. Do not turn the electrical supply on again until the product has been checked and approved by a qualified installer.

Following Installation and Commissioning of the product, the operation should be fully explained to the user.

Hot water

- ▶ Indicate the location of the product and identify the outlets to which it is connected.
- ▶ Explain that the temperature is set upon installation and confirm the temperature which the water is set at.

System malfunction

- ▶ Explain how to isolate electrical and water supplies in case of a fault.
- ▶ Explain that a qualified plumber and/or electrician should be contacted if there is a fault.
- ▶ Explain how to identify/check basic faults.

Maintenance

- ▶ Explain the necessity to carry out regular maintenance of the product to ensure its continued safe and efficient operation.

Literature

Hand over the Installation and user instructions.

- ▶ The product stores water at the temperature set on the adjustable thermostat. This can be set to give temperatures in the range of 10 to 70°C. To avoid any risk of freezing when the product is not in use for long periods during the winter months, do not switch off the electrical supply and set the thermostat to its minimum position. N.b. this will not protect other system pipework.
- ▶ The thermostat can also be locked in either the mid range or a "hot" (recommended when using in conjunction with a Thermostatic Blending Valve) position. To lock the thermostat position, the instructions given under Sections 4.2.3 or 4.2.4 should be followed. We recommend that this procedure is carried out by a qualified electrician.
- ▶ The indicator light will be illuminated when the product is heating.

9. Maintenance

9.1 General

Maintenance requirements

Unvented hot water systems have a continuing maintenance requirement in order to ensure safe working and optimum performance. It is essential that the relief valve is periodically inspected and manually opened to ensure no blockage has occurred in the valves or discharge pipework. Maintenance of this appliance should only be carried out by a suitably qualified person. Failure to do so could invalidate the warranty.



WARNING

Disconnect from all electrical supplies before beginning any work on the product. Water contained within the product may be very hot!

Maintenance should be carried out by a competent person and any replacement parts should be authorised Heatrae Sadia spare parts.

It is recommended that maintenance is carried out annually and should include the checks detailed in the sections below.

Little maintenance is required, however in hard water areas the product will require periodic descaling to ensure efficient operation.

9.2 Standard inspection & maintenance operations

To descale:

- ▶ Switch off and disconnect the electrical supply. Turn off the water supply to the product.
- ▶ Open a hot tap to relieve any system pressure. Disconnect the plumbing connections to the product and remove from the wall bracket (note full weights of product). Empty the product through the outlet connection.
- ▶ Remove the terminal cover by using a large flat bladed screwdriver to depress the 3 snap lugs located in the top 3 rectangular depressions.
- ▶ Remove the insulating pad from the terminal housing. Disconnect the electrical terminations to the thermostat. Disconnect earth links to the earthing stud.
- ▶ Remove the element plate assembly by unscrewing the five securing screws, a tapped

jacking point is provided. Remove any loose scale from the container. Carefully clean off any scale from the element and thermostat pocket. DO NOT clean scale from interior container walls.

- ▶ Re-assemble the element plate assembly fitting a new sealing gasket. Note the correct orientation of the element plate by reference to Figure 07 below. Rewire the product with reference to the Wiring Diagrams. Refit the insulating pad to ensure the correct operation of the thermostat.

Figure 7 – 3kW model

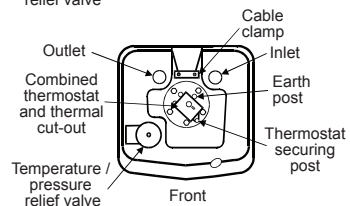
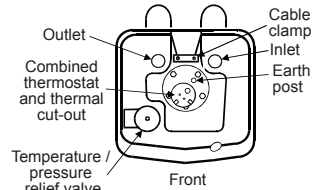

Figure 7 – 4.5kW model

- ▶ Re-commission the product following the Installation and Commissioning instructions.
- ▶ The Temperature/Pressure Relief Valve and, if fitted, the Pressure (expansion) Relief Valve should be regularly checked. This is to remove limescale deposits and to verify that it is not blocked. To check the valves: Manually operate the valves by either twisting the cap or lifting the lever. Ensure water flows freely from the valve(s) and through the discharge pipes. Ensure the valve(s) reseal correctly when released.
- ▶ The Expansion Vessel, if fitted, should have a pre-charge pressure of 0.41 MPa (4.1 bar). This can reduce over time and eventually require re-charging. To do this:
 - ▶ Turn off water supply to the product; open a hot tap to relieve system pressure.
 - ▶ Remove dust cap from top of Expansion Vessel
 - ▶ Check pre-charge pressure using a tyre pressure gauge. If the pressure is lower than 0.41 Mpa (4.1 bar) it should be recharged using a tyre pump (Schraeder Valve type). DO NOT OVER CHARGE.
 - ▶ Re-check pressure and when correct replace dust cap.
 - ▶ Turn on mains water supply and close hot tap.

10. Troubleshooting



WARNING

Do not tamper with any of the safety valves or controls supplied with the cylinder as this will invalidate any guarantee

10.1 Fault finding

Disconnect the electrical supply before removing the terminal cover. It is recommended that any service operations on the product are carried out by a competent person.

Symptom	Possible cause	Remedy
Water not heating	A. Electrical supply fault	A. Check electrical supply
	B. Thermal cut-out tripped	B. Check cut-out, if operated reset and check thermostat operation. If necessary replace thermostat/thermal cut-out (see wiring diagram)
	C. Thermostat fault	C. Check thermostat operation. Replace if necessary
Discharge of water from pressure relief valve (continuously)	Excessive mains water pressure	Fit Pressure reducing valve Pack U1 and U2 (see important installation points)
Discharge of water from Pressure relief valve (intermittently)	A. Expansion in mains not possible	A. Fit pack U2 (see important installation points)
	B. Mains pressure exceeds 0.41 MPa (4.1 bar)	B. Fit packs U1 and U2
	C. Pack U1 fitted without pack U2	C. Fit pack U2 when using pack U1
	D. Pressure relief valve fault	D. Replace pressure relief valve
	E. Loss of pressure from expansion vessel	E. Check and if necessary re-charge Expansion vessel pre-charge pressure (see section 9)
Discharge of water from Temperature / pressure relief and/ or water/steam from pressure relief valve	Thermostat and thermal cut-out fault	Replace thermostats and thermal cut-outs
No water flow	A. Inlet vales incorrectly fitted	A. Check all vales are correctly installed in accordance with flow direction arrows
	B. Mains water supply not turned on	B. Check mains water supply is on
	C. Blockage in mains water supply	C. Check for obstructions. If pack U1 is fitted check the strainer is not blocked
'Milky water'	Oxygenated water	Water from a pressurised system releases oxygen bubbles when flowing. The milkiness will disappear after a short while

11. Decommissioning procedure

- ▶ Isolate electrical supplies and make safe
- ▶ Isolate the water supply
- ▶ Drain the product
- ▶ Remove product
- ▶ Cap pipework

Environmental information

The Waste Electrical and Electronic Equipment (Producer Responsibility) Regulation 2004

This product is outside of the scope of the European Waste Electrical & Electronic Equipment Directive as interpreted within the UK.

In the UK this product can therefore be disposed of through commercial non-WEEE waste facilities.

Heatrae Sadia does not accept any liability under the WEEE directive.

This product is manufactured from many recyclable materials. At the end of its useful life it should be disposed of at a Local Authority Recycling Centre to realise the full environmental benefits.

Insulation of the product is by means of an approved CFC/HCFC free polyurethane foam with an ozone depletion factor of zero and a Global Warming Potential (GWP) of 3.1.

The product does not contain any substances harmful to health; it does not contain any asbestos.

12. Spare parts

The following comprehensive list of spare parts is available for your product. Please refer to the Rating Label on the side of your product before ordering to ensure the correct spare part is obtained.

Do not replace with parts not recommended by Heatrae Sadia - this will invalidate your warranty and may render the installation dangerous.

Description	Code No
Element plate assembly - 10 litre 3kW	95 606 921
Element plate assembly - 15 litre 3kW	95 606 922
Element plate assembly - 10 litre 4.5kW	95 606 923
Element plate assembly - 15 litre 4.5kW	95 606 924
Combined thermostat/thermal cut-out 3kW	95 612 633
Combined thermostat/thermal cut-out 4.5kW	95 612 634
Indicator light 3kW	95 607 992
Indicator light 4.5kW	95 607 993
Element plate gasket	95 611 708
Pressure (expansion) Relief Valve	95 607 986
Temperature/Pressure Relief Valve	95 605 045
Check Valve	95 607 987
Expansion Vessel	95 607 988
Pressure Reducing Valve	95 607 989
Top cover moulding	95 614 181
Terminal cover c/w thermostat knob	95 614 182



Accessories

The product can be used to supply several hot water outlets via conventional taps. It is not recommended for supplying a shower. Individual site demands should be considered when choosing capacity and the number of outlets to be served.

A Thermostatic Blending Valve can be used in conjunction with this product. Accessory Pack U3 (code no. 95 970 354) is recommended. Follow the installation instructions supplied with the valve for connection to the system.

Warranty

The product warranty is for a period of five years from the date of purchase with the exception of the immersion heater and thermal controls which are covered for a period of two years provided:

1. The product has been installed in accordance with these instructions and all necessary inlet controls and safety valves have been fitted correctly.
2. Any valves or controls are of Heatrae Sadia recommended type.
3. The product has not been tampered with and has been regularly maintained as detailed in these instructions.
4. The product has been used only for heating potable water.
5. Within 60 days of installation, the user completes and returns the certificate supplied along with proof of purchase to register the product.

The product is not covered against damage by frost and the immersion heater is not covered against excessive scale build up.

This warranty does not affect the statutory rights of the consumer.

HEATRAE SADIA

SMARTER | CLEANER | WARMER

Electric Water Heating Co.
2 Horsecroft Place
Pinnacles
Harlow
Essex CM19 5BT
Tel: 0845 055 3811
E-Mail: sales@ewh.co.uk

SPD
Special Product Division
Units 9 & 10
Hexagon Business Centre
Springfield Road
Hayes
Middlesex UB4 0TY
Tel: 020 8606 3567

Parts Center
Tel: 0344 292 7057
www.partscenter.co.uk

Newey & Eyre
Unit 3-5 Wassage Way
Hampton Lovett Ind. Estate
Droitwich, Worcestershire
WR9 0NX
Tel: 01905 791500
Fax: 01905 791501

UK Spares Ltd
Unit 1155
Aztec West
Almondsbury
Bristol BS32 4TF
Tel: 01454 620500

Alternatively contact your
local supplying merchant
or wholesale branch or use
our online stockist finder at
www.interpartspares.co.uk

SPECIFICATION ADVICE HOTLINE

t | 01603 420220 e | specifier@heatraesadia.com

AFTER SALES SERVICE

t | 0344 871 1535 e | customer.support@heatraesadia.com

w | heatraesadia.com



OUR NATIONWIDE NETWORK OF CUSTOMER SUPPORT ENGINEERS

Heatrae Sadia has its very own dedicated nationwide network of highly trained customer support engineers so you can have peace of mind that we're always here to help.

PRODUCT RANGE

Full specification details on all our products are available to download from our website.

To support our corporate responsibility and sustainability charters and reduce our printed material we encourage you to download product brochures from our website.

In designing these files we have taken into account the need to access data on screen.

If you would like to receive a printed copy of our full product catalogue please call our literature hotline on 01603 420127.

Heatrae Sadia may introduce modifications to their products from time to time. Consequently, the details given in this brochure are subject to alteration without notice.

Please follow us online:



PN 36 00 5718 Issue 9
© Heatrae Sadia 2015