

Electronic Instant Hot Water Appliance

Installation, Operation and Care Instructions

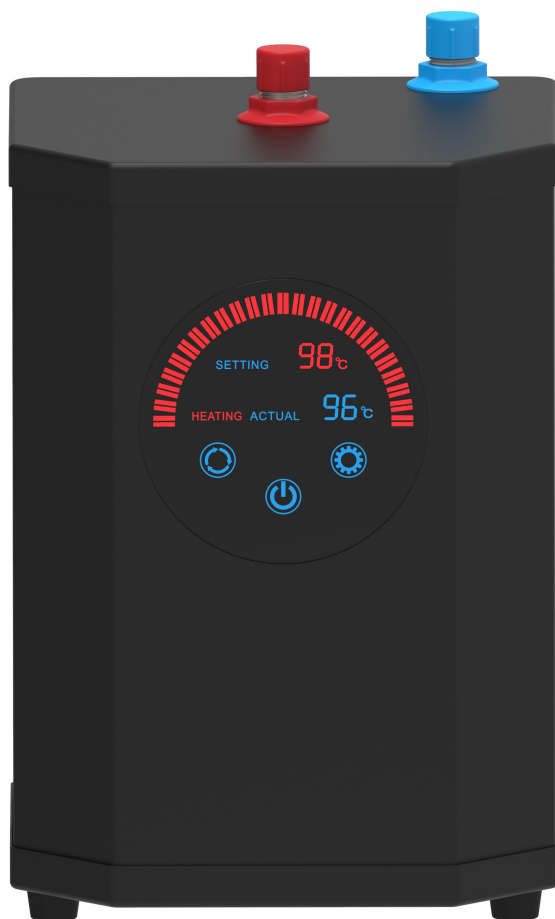

Please read and fully understand this guide to the installation, operation and maintenance for your 3-1 Instant hot kitchen tap. Please read and fully If in doubt contact a qualified

plumber or retailer to assist. Do not plug in the Instant Hot Water Tank, until all water connections have been made and checked for being water tight and the Instant Hot Water Tank must be filled with water. The Instant Hot Water Tank is filled once water starts to pass out of the tap spout. It is recommended before using the tank, to flush through several litres of water before using to remove air from system.

For your safety and satisfaction please read all the instructions, cautions and warnings before installing or using this electronic instant hot water appliance.

This electronic instant hot water appliance is not intended for commercial use

IMPORTANT NOTICE: This product can cause harm if installed incorrectly and should only be installed by a competent person, if you feel for any reason unsure about the installation please contact a qualified plumber or electrician to install the appliance.

Make sure all electrical wiring and connections conform to local standards.

Make sure all water connections conform to local standards.

Make sure all electrical wiring and water connections conform to local codes. Standard 220/240v grounded 13 amp switched electrical outlet is required under the sink. If possible, use a separate circuit dedicated to your Hot Tank.

The instant hot water appliance is an open vented system appliance. The operating pressure is 1.5 bar to maximum of 5 bar.

The water filter must be connected to the electronic instant hot water appliance and replaced every 6 months or the guarantee will be void.

Equipment Required:

Tape Measure



Adjustable Wrench



SAFETY INSTRUCTIONS PLEASE READ BEFORE YOU START

The alert symbols displayed on the right point to important safety information to make you aware of potential hazards that can cause serious injury or death. Please pay special attention to the information following these warning alerts. Failure to comply with these instructions could result in property damage, serious injury or death.

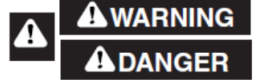

Please read this chapter carefully for your own safety and the safety of those around you. Please read the safety information in this instruction, installation guide and on the product, in order to install and use the product accordingly, so as to avoid any injury. The safety information will tell you what the potential danger is, how to avoid it, and identify what will happen if you do not operate following the instruction.

Electric Shock: Using an ungrounded connection or improper connection of the power supply to the product can result in a serious injury or death from electrical shock.

Electric Shock: Do not remove the earthing terminal

Do not reconstruct the plug

Do not disassemble main box and any part for the power.



Important

The instructions are only intended as a guide, if there is any doubt then please contact a certified plumber or electrician or point of purchase and avoid using the appliance until it has been checked.

COMPONENTS INCLUDED

The electronic instant hot water appliance is supplied with the following:

Electronic Instant Hot Water Appliance with IEC power lead.

The water connections are to allow correct connections from the instant hot water tap to the electronic instant hot water Appliance.

Outlet Connectors— 3/8" Brass plated to silicon connector

IMPORTANT SAFETY INSTRUCTIONS

PLEASE READ ALL INSTRUCTIONS CAREFULLY



When using all electrical appliances, basic safety precautions should always be followed including the information below:

To protect against electrical shock, do not place cord, plugs or unit near or in water or other liquids and do not operate the electronic instant hot water appliance controls or power socket with wet hands.

Check the power rating of your electronic instant hot water appliance is suitable for the power rating of the electrical circuit it is being installed on.

Do not operate or install the electronic instant hot water appliance if it appears to have any missing parts, be damaged / faulty eg damaged cord, plug.

Do not use outdoors or in a damp area.

Do not use the electronic instant hot water appliance for anything other than the intended **Domestic** use only.

The electronic instant hot water appliance must be installed vertically as shown on front cover with inlet and outlet connections at the top of appliance.

Ensure the front of the unit is visible and the front temperature dial can be easily reached.

Do not attempt to open, modify or service this electronic instant hot water appliance. Repairs should be carried out by Authorised Service personnel. Opening the unit will void the guarantee.

The instant hot water appliance is an open vented system appliance. The operating pressure is 1.5 bar to 5 bar

Turn off all controls before unplugging.

Do not unplug by pulling the cable. To unplug, grasp the plug, not the cable.

Property Damage: To avoid the risk of flooding, regularly inspect the connections for any signs of leakage.

This electronic instant water appliance is not intended for use by persons (including children) with reduced physical, sensory or mental capabilities, or lack of experience and knowledge, unless they have been given supervision or instruction concerning use of the appliance by a person responsible for their safety. Children should be supervised to ensure that they do not play with the electronic instant hot water appliance or instant hot water tap, a safety springback handle is used to control the flow of the near boiling water for additional safety.

INSTALLATION REQUIREMENTS

Electrical Requirements



A 220/240-volt, 50 Hz, AC-only 13 amp fused, grounded electrical power supply is required. It is recommended that a separate circuit serving only your electronic instant hot water appliance be provided or use an outlet that can be turned on/off by a switch.

This electronic instant hot water appliance is equipped with a power supply cord with a power plug. To minimise possible shock hazard, the cord must be plugged into mating, ground-type outlet, grounded in accordance with all national and local codes and ordinances. If a socket outlet is not available, it is the responsibility and obligation of the customer to have a properly grounded outlet installed by a qualified electrician.

Water Supply Requirements



If local codes permit, the instant hot water tap feed line should be connected to the hot and cold water supply line using an isolation valve or another means for providing the hot and cold water to the tap. IMPORTANT: If local codes do not permit the use of isolation valves, special feed valves can be obtained from your local plumbing supply distributor.

If the water is mixed with impurity, ironing chips, grains of sand, and so on, the pipes of the electronic instant hot water appliance and tap will be blocked and will void the guarantee.

Environment requirement



Don't install the electronic instant hot water appliance outdoors or in a location that may fall below zero degrees C, otherwise the pipes and the tap and tank will be frozen and there will be serious safety trouble, possible bodily-injury, accidents and damaged caused and the guarantee will be void.

It's forbidden to wash the electronic instant hot water appliance with water directly.

The installation environment should be ventilated, with protection from the direct sunshine. When installing the electronic instant hot water appliance, provide approximately 10cm to 15cm (4 - 5 ½") of air space on the sides of the unit for air circulation and approximately 2.5cm (1") from the mounting wall.

The environment humidity should be in the range of 10% to 60%. Be sure there is no dew.

Instant Hot Water Tap Information

Connecting a standard tap may



cause injury and will damage the electronic instant hot water appliance and void the guarantee. Due to high water temperature, and for safety reasons, the electronic instant hot water appliance is not under pressure.

Instant Hot Water Appliance Temperature Adjustment

For temperatures above 203F:- it has been set for optimum performance in most common and typical known installations. However there are factors which may influence the performance of the instant hot water appliance such as incoming water temperature, atmospheric pressure and altitude. Should you experience any discharge of water from the spout during heat up, you can reduce the setting to compensate for this by 1– 2°C degrees. If in doubt please ask your dealer for further guidance.

PREPERATION FOR INSTALLATION

Unlike other household hot water appliances, this electronic instant hot water appliance is Non Pressurised for safety reasons. For this electronic instant hot water appliance, the **Instant Hot Tap** is placed before the electronic instant hot water appliance, creating an “open vent” system and consequently no pressure is built up inside the appliance.

IMPORTANT: Install the Instant Hot Water Tap in accordance with the fitting Instructions provided with the Hot Water Tap. 

Preparation for the electronic instant hot water appliance installation

IMPORTANT: Observe all local governing codes and ordinances.

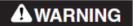

The electronic instant hot water appliance must be mounted vertically and level.

Before you begin, select a proper location ideally directly under the instant hot water tap or close to it to ensure the connection pipes will connect from the instant hot water tap to the electronic instant hot water appliance.

The electronic instant hot water appliance is not under pressure, consequently, there is a slight delay in water flow after the hot water springback tap handle has been turned on. This is normal and indicates that the electronic instant hot water appliance is functioning properly.

It is recommended that you have access to a separate power circuit serving only your electronic instant hot water appliance. See previous pages for more information on “ELECTRICAL REQUIREMENTS”.

INSTALLATION

Step 1– Position the Instant Hot Water Appliance



Ensure the electronic instant hot water appliance is **NOT** connected to the Electric Power during installation.

Place the electronic instant hot water appliance in position and check to ensure that the instant hot water tap connection pipes and the power cord will reach without being stretched.

The electronic instant hot water appliance must be positioned so the tubes from and to the instant hot water tap do not twist or kink.

INSTALLATION CONTINUED

Step 2 – Connect Tap

Should you require any advice on the installation then please seek guidance from your Retailer or a Qualified Plumber.

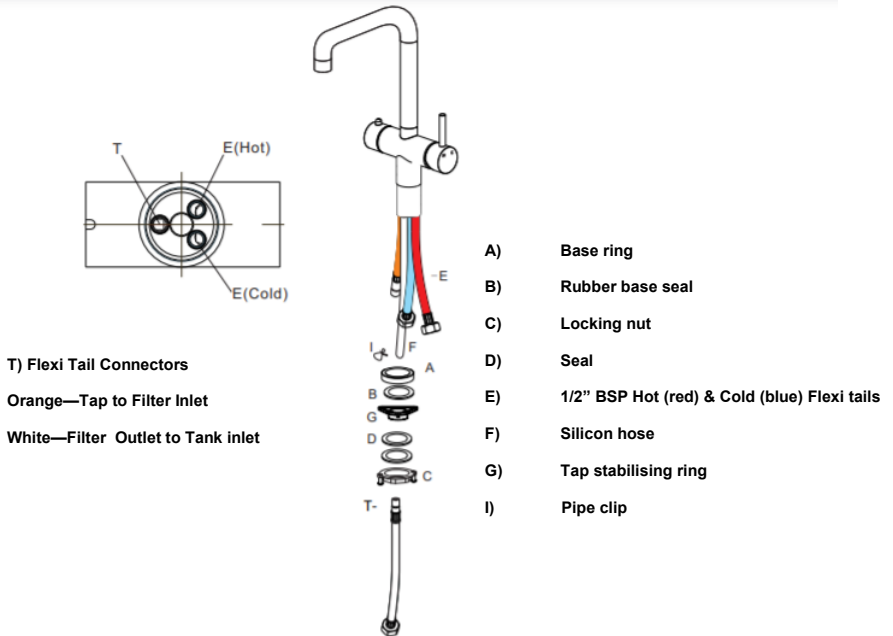

(i) Feed the flexible connections through the work surface hole $\Phi 35\text{mm}$, ensuring the base seal is in place between tap and mounting surface.

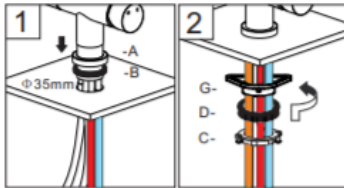

(ii) Ensure the tap is orientated correctly i.e. The spout fixing screw should be at the back. The hot water lever should rotate to point backwards.

(iii) Secure the tap in position using the locking nut C).

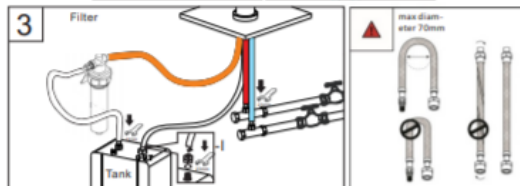

Avoid kinking tubes during installation as this could restrict flow and cause malfunctioning of appliance. Do not use pipe sealing compounds on any connections. These can foul the internal mechanics and may cause objectionable taste and odour. Plumbing connections must comply with all sanitary, safety and plumbing standards

INSTALLATION CONTINUED

Step 2 – Connect Tap

How to use your 3-1 Sink Mixer Tap with Instant Hot Water:

(I) For Instant Hot Water depress the small button on left hand side of the tap. Keep the button pressed down and rotate the handle to dispense instant hot water from the tap.

(ii) For mixed water, pull large lever on right side away from the body, then rotate backwards for mains hot & forwards for mains cold water dispensing.

Regulations Requirements :

It is important to ensure that the water supplies to your tap, is connected in accordance with the water regulation requirements, plumbing code and good plumbing practice.

Water Supply Pressures :

This tap has been designed to function with a minimum supply pressure for cold water of 1.5bar. The Maximum supply pressure must not exceed 5 bar. Should excessive pressure be experienced, a Pressure Reducing Valve must be used.

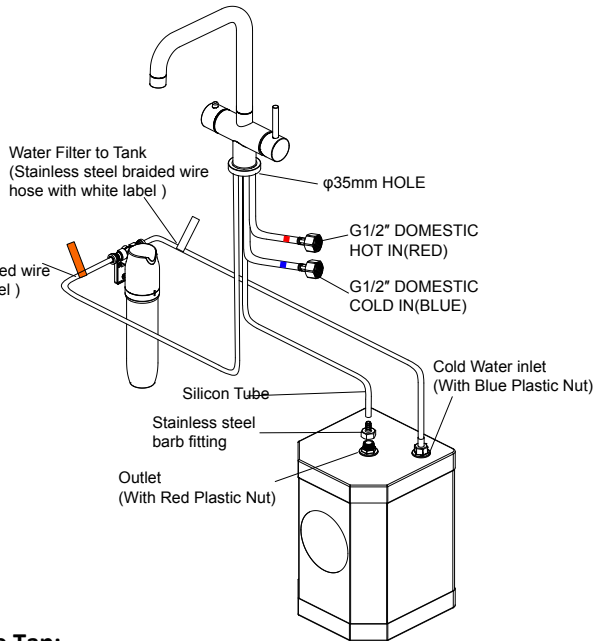

Important: Care and Maintenance of the Tap:

Only clean the tap with a soft cloth, warm water and a mild detergent solution. Rinse the tap clean thoroughly afterwards with water. Do not use any abrasive or harsh chemical products; otherwise this will invalidate your guarantee.

The electronic instant hot water appliance inlet connection is a 3/8" BSP male threaded connector. The outlet connector is a 3/8" BSP male thread connector. Check the connections type and size on the instant hot water tap for the inlet and outlet connections. Screw on the inlet and outlet pipe the correct connectors and tighten with a wrench. Connect the cold and hot tap inlet hoses to the mains in the normal way. Fitting a pressure reducing valve to the cold mains inlet if the mains pressure is above 5bar. Tighten with a wrench and move to check the complete installation for leaks.

FILTER INSTALLATION

1. If wish to use the bracket to fix the filter inside your cupboard then swivel the head of the filter, to rotate the main body of filter clear from the 3 holes (A) of the bracket. Use a pencil to mark through the 3 holes to position the bracket. Use a Philips screw driver to fasten the bracket with the 3 woodscrews provided into position.

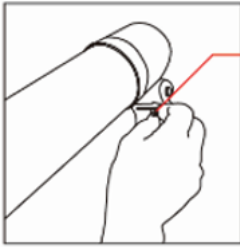

(A)

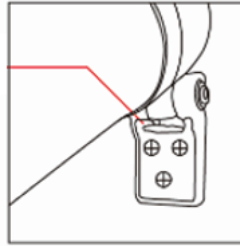

(B)

2. Push both 3/8" - 1/4" push reducer fittings that are supplied with the product into the inlet and outlet ports of the filter. Please note the direction of the arrow for flow as shown beneath.
A – Fit the Tap outlet flex with White label to push into the 'OUT' connector.
B – Fit the Tap inlet flex to push into the 'IN' connector – Use flex with Orange label.

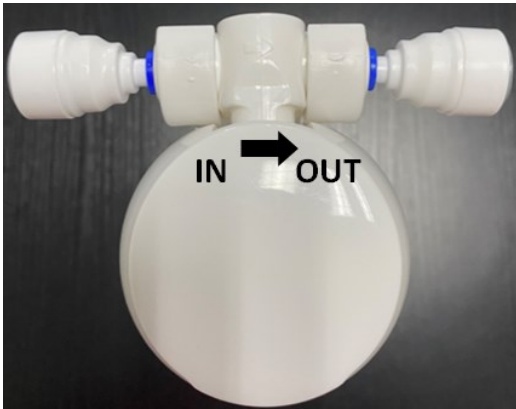

1/4" PF X 3/8"PF Connectors



Flex Connectors Tap to Filter & Filter to Tank.

3. Turn on the water supply and check for leaks. We recommend that you flush at least 2 litres of water through the system. Write the installation and filter change dates on the label.

INSTALLATION CONTINUED

Step 3 – Priming and Checking for Water Tightness

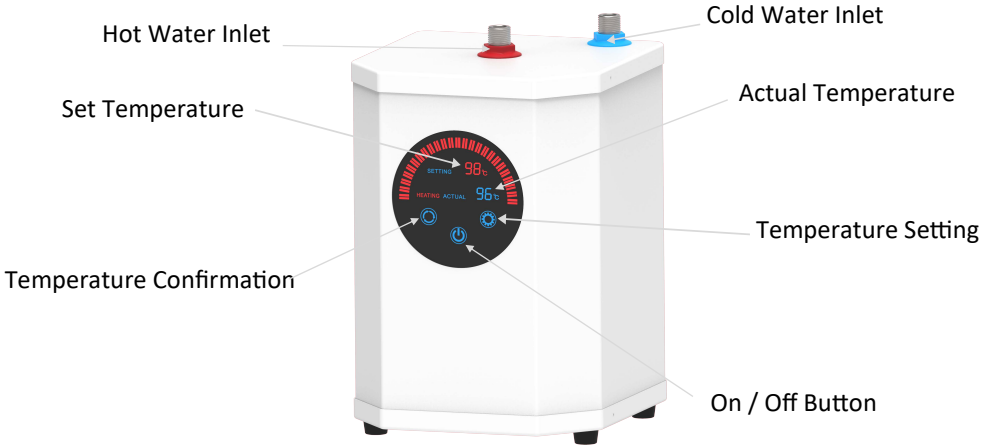

Before the electronic instant hot water appliance is plugged into the power socket it must be tested for water tightness and no leaks.

Open all supply water valves to allow water to flow to the instant hot water tap. To fill the tank press the spring back lever on hot side down and rotate to dispense water. It will take about 90 seconds before water starts to dispense from the tap as the tank will fill first.

When the electronic instant hot water appliance is full, water will flow from the instant hot water tap spout.



Turn the instant hot water handle off and check all connections for

water tightness and leaks.

Any leaking joint must be tightened to ensure no water leakage and the above priming undertaken again and checked for water tightness before connecting to the power socket.

Once sure system water tight dispense at least 2 litres of water to remove air from system.

INSTALLATION CONTINUED

Step 4 – Electrical Connection

Ensure that the installation area is dry and no water has spilled.

Connect the plug to the power socket and turn on the power socket at the switch.

The electronic instant hot water appliance display panel will now light up with the on / off button illuminated.



Step 5 –Electronic Instant Hot Water Appliance Operation

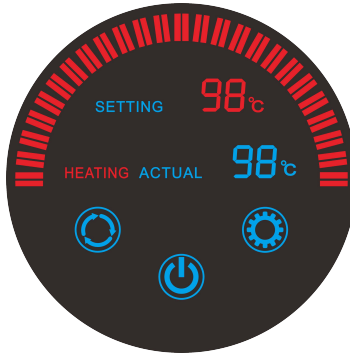

Electronic Control Display Panel



ON/OFF to control the power it will also control the display ON/OFF.





Confirmation and heating control switch



Temperature setting, 7 temperature settings: 98°C max. 97°C; 96°C; 95°C; 90°C 85°C; 75°C.

To turn on the electronic instant hot water appliance touch the  button and hold for 3 seconds until the display lights up.

Touch the  button and press each time so that the temperature settings will change from 75°C; 85°C; 90°C; 95°C; 96°C; 97°C; 98°C continue to press till the required temperature is seen. To confirm the temperature and start the

electronic instant hot water appliance press the  button and the electronic instant hot water appliance will start to heat up the water and an audible beep will be heard.

INSTALLATION CONTINUED

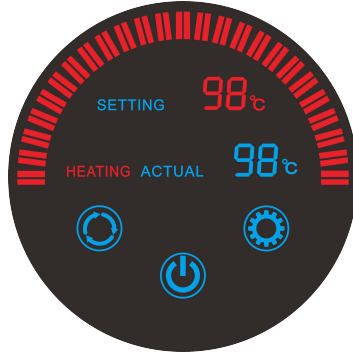

If the electronic instant hot water appliance is empty of water and is turned ON then this will be automatically sensed, the heating element will not energise and the “lack of water” indicator will be flashing on the display panel shown by the flashing of the E3 warning. code.

If the E3 “lack of water” code is seen the dry-burn protection sensor has activated automatically due to the lack of water in the electronic instant hot water appliance.

If the “lack of water” code is seen then touch the power off button and prime the electronic instant hot water appliance using the instruction set out earlier to fill with water.

If the electronic instant hot water appliance is not powered off or filled with water then after approximately 5 minutes the electronic instant hot water appliance will automatically power down until it is primed with water using the instruction set out earlier.

The Actual Temperature will display the approximate water temperature at the thermostat position. When the electronic instant hot water appliance is in heating mode there will be a moving red arc line of lights to indicate the electronic instant hot water appliance is heating up. Once the required set temperature is reached the red arc line will become static. There are two display boxes Heating and Hot when the tank is heating up the Heating will be lite and when temperature is achieved this will then lite up the Hot display box.

When the instant hot water is drawn from the instant hot water tap or the water temperature falls in the electronic instant hot water appliance falls below the required temperature setting then it will automatically re heat to the required temperature setting.

To turn off the electronic instant hot water appliance at any time press the  button.

MAINTENANCE AND CARE INSTRUCTIONS CONTINUED

Flushing the Instant Hot Water Tank



It is recommended that the user flushes through the system completely by drawing off the instant hot water and allowing to reheat and repeating the process for a further 2 or 3 times to ensure the system is fully operational.

Water Draw Back and Contamination in the Tank



During the filling of any vessel the user must ensure at all times that the spout outlet is not submerged in the water during the dispensing of the instant hot water and especially when the instant hot water handle is released.

Maintenance & Power Saving

If the electronic instant hot water appliance is not being used for long periods of time ie: over 2 days, to save power we recommend you switch off using the “ON/OFF” switch.

Seasonal Shutdown

The hot water system (tank and tap) must not be exposed to freezing temperatures. If there is a possibility of this the system must be drained of water. Shut-off the mains supply and unplug the unit from the electricity mains and allow the tank to cool for at least 1 hour. Disconnect the inlet supply to the tank and remove the silicone hose outlet pipe, lift the unit to the sink, turn upside down and drain all the water from the tank. When re-installing follow the original installation instructions.

NOTICE

The electronic instant hot water appliance like any water heater has a limited operational life span and will eventually fail. In order to ensure maximum protection and to avoid possible damage to any property or personal injury the electronic instant hot water appliance should be inspected regularly for any water leakage or damage.

Regularly check for any signs of water leakage, if there is any water leakage then replace any loose or split silicon tubes or flexi tails which can cause water leakage and damage.

To provide additional water security to avoid property damage the electronic instant hot water appliance can be placed in a drain pan and connected to a suitable drain outlet to avoid any water damage. The drain pan should be installed using the manufacturers installation instructions.

TROUBLE SHOOTING

PROBLEM	POSSIBLE CAUSE	WHAT TO DO
Water and Steam is spitting from the instant hot water tap spout	Unit is boiling	Turn the instant hot water tap handle on and release the water.
		Adjust the water temperature on the display to a lower setting.
		Check aerator is not blocked Bleed system to remove any air Re-Prime bladder to allow correct operation.
Water is not hot.	The electronic instant hot water appliance is unplugged.	Make sure the electronic instant hot water appliance is plugged in and connected to a grounded electric outlet
		Make sure that the circuit breaker and fuse are working correctly
	The electronic display has not been powered up	Turn on the power and touch the on / off button and then set the required temperature and confirm the heat up.
Water is too hot.	Water temperature setting on display panel is set to high.	Re-set the temperature to the required temperature and confirm the heating up
Water is dripping from the instant hot water tap spout.	The expansion chamber isn't draining the system correctly due to very small draw off of water	Draw off 1 Litre of water to clear and prime the system. Avoid less than 100ml of a pint draw offs of water. Remove and clean the aerator. Check silicon pipe length. Remove and clean the aerator.
	The spout is blocked	

TROUBLE SHOOTING CONTINUED

PROBLEM	POSSIBLE CAUSE	WHAT TO DO
Slow Flow from the spout	Water Filter may be clogged from impurities in the inlet mains water	The water filter must be changed every 6 months or this will void the guarantee
Water does not flow straight away	The electronic instant hot water appliance is design for non-pressurised operation and there will be slight delay till the near boiling water appears	After a large volume of water has been drawn off there may a slightly longer delay in the water appearing from the instant hot water tap spout
No Water Flowing	Water Valves have been turned off Inlet Pipes have been twisted or blocked	Turn on all the water valves Ensure the pipes are not twisted or kinked to restrict flow Remove and clean the aerator Remove the electronic instant hot water appliance as per the de scaling instructions and flush through all pipes to ensure water flow.

IF YOU ARE IN ANY DOUBT THEN POWER OFF THE ELECTRONIC INSTANT HOT WATER APPLIANCE AND CALL THE SERVICE AGENT



Information on Disposal for Users of Waste Electrical & Electronic Equipment (private households)

This symbol on the product and / or accompanying documents means that used electrical and electronic products should not be mixed with general household waste. For proper treatment, recovery and recycling, please take this product to designated collection points where it will be accepted free of charge.

Alternatively, in some countries you may be able to return your products to your local retailer upon purchase of an equivalent new product.

Disposing of this product correctly will help save valuable resources and prevent any potential negative effects on human health and the environment, which could otherwise arise from inappropriate waste handling.

Please contact your local authority for further details of your nearest designated collection point.

Penalties may be applicable for incorrect disposal of this waste, in accordance with your national legislation.

For business users in the European Union

If you wish to discard electrical and electronic equipment, please contact your dealer or supplier for further information.

Information on Disposal in other Countries outside the European Union

This symbol is only valid in the European Union. If you wish to discard this product please contact your local authorities or dealer and ask for the correct method of disposal.