



# X1 Series User Manual

3.0kW - 6.0kW



EN



## Solax Power Network Technology(Zhejiang) Co., Ltd.

No.288, Shizhu Road, Tonglu Economic Development Zone,  
Tonglu City, Zhejiang Province, 310000 P. R. CHINA  
Tel: +86 (0) 571-56260011  
E-mail: info@solaxpower.com

### Copyright Declaration

The copyright of this manual belongs to SolaX Power Network Technology (Zhejiang) Co., Ltd. Any corporation or individual should not plagiarize, partially or fully copy it (including software, etc.), and no reproduction or distribution of it in any form or by any means shall be allowed. All rights reserved. SolaX Power Network Technology (Zhejiang) Co., Ltd. reserves the right of final interpretation.

320101034604

[www.solaxpower.com](http://www.solaxpower.com)

## CHANGE HISTORY

Changes between document versions are cumulative. The latest version contains all updates made in previous versions.

### **Version 04 (Nov. 09, 2022)**

Updated 4 Technical Data (Added technical data)

Updated 5.4 Installation Steps (Added the parallel function)

### **Version 03 (Oct. 31, 2022)**

Updated 4.2 AC Output (Added the safety regulation of Belgium for 4.6KW and 5KW)

### **Version 02 (Dec. 09, 2022)**

Updated 2.3 Explanation of Symbols (Modified TUV mark)

Updated 5.4 Installation Steps (Modified screws and tools used in the installation; Modified CT image)

### **Version 01 (Feb. 11, 2022)**

Updated 4.2 AC Output (Added the safety regulation of Belgium)

Updated 5.4 Installation Steps (Added the upgrade content and modified the pin definition of DRM)

### **Version 00 (Dec. 30, 2021)**

Initial release

## Contents

1 Note on this Manual	03
1.1 Scope of Validity	03
1.2 Target Group	03
1.3 Symbols Used	03
2 Safety	04
2.1 Appropriate Usage	04
2.2 Important Safety Instructions	06
2.3 Explanation of Symbols	09
2.4 EC Directives	10
3 Introduction	10
3.1 Basic Features	10
3.2 Terminals of the Inverter	11
3.3 Dimension	12
4 Technical Data	13
4.1 DC Input	13
4.2 AC Output	13
4.3 Efficiency, Safety and Protection	14
4.4 General Data	14
5 Installation	15
5.1 Check for Transport Damage	15
5.2 Packing Lists	15
5.3 Installation Precaution	16
5.4 Installation Steps	17
5.5 Connections of the Inverter	17
5.6 Run the Inverter	32
6 Operation Method	33
6.1 Control Panel	33
6.2 LCD Structure	34
6.3 LCD Operation	35

7 Troubleshooting ..... 41

7.1 Troubleshooting ..... 41

7.2 Routine Maintenance ..... 44

8 Decommissioning ..... 45

8.1 Dismantling the Inverter ..... 45

8.2 Packaging ..... 45

8.3 Storage and Transportation ..... 45

8.4 Disposing of the X1-Boost ..... 45

9 Disclaimer ..... 46

10 Commissioning ..... 47

\* Warranty registration form

# 1 Notes on this Manual

## 1.1 Scope of Validity

This manual is an integral part of X1 Series. It describes the assembly, installation, commissioning, maintenance and failure of the product. Please read it carefully before operating.

X1-3.0-T-D(L)	X1-3.3-T-D(L)	X1-3.6-T-D(L)	X1-4.2-T-D(L)
X1-3.0-T-N(L)	X1-3.3-T-N(L)	X1.3.6-T-N(L)	X1-4.2-T-N(L)
X1-4.6-T-D(L)	X1-4.6K-T-D(L)	X1-5.0-T-D(L)	X1-5.0K-T-D(L)
X1-4.6-T-N(L)	X1-4.6K-T-N(L)	X1-5.0-T-N(L)	X1-5.0K-T-N(L)
X1-5.5K-T-D(L)	X1-6K-T-D(L)		
X1-5.5K-T-N(L)	X1-6K-T-N(L)		

Note: “**3.0**” means 3.0 kW. “**T**” means “double” MPPT strings. “**D**” means with “DC Switch”, “**N**” means without “DC Switch”. “**L**” means with “LCD display”, “**X1**”: Single Phase, “**K**”: kW.

**X1-4.6K-T-D(L)/X1-4.6K-T-N(L)/X1-5.0K-T-D(L)/X1-5.0K-T-N(L)** is for C10/11.

Keep this manual at where is accessible all the time.

## 1.2 Target Group

This manual is for qualified electricians. The tasks described in this manual only can be performed by qualified electricians.

## 1.3 Symbols Used

The following types of safety instructions and general information appear in this document as described below:



**DANGER!**  
“Danger” indicates a hazardous situation which, if not avoided, will result in death or serious injury.



**WARNING!**  
“Warning” indicates a hazardous situation which, if not avoided, could result in death or serious injury.



**CAUTION!**  
“Caution” indicates a hazardous situation which, if not avoided, could result in minor or moderate injury.



**NOTE!**  
“Note” provides tips that are valuable for the optimal operation of your product.

## 2 Safety

### 2.1 Appropriate Usage

The X1 Series are PV inverters which can convert the DC current of the PV generator into AC current and feed it into the public grid.

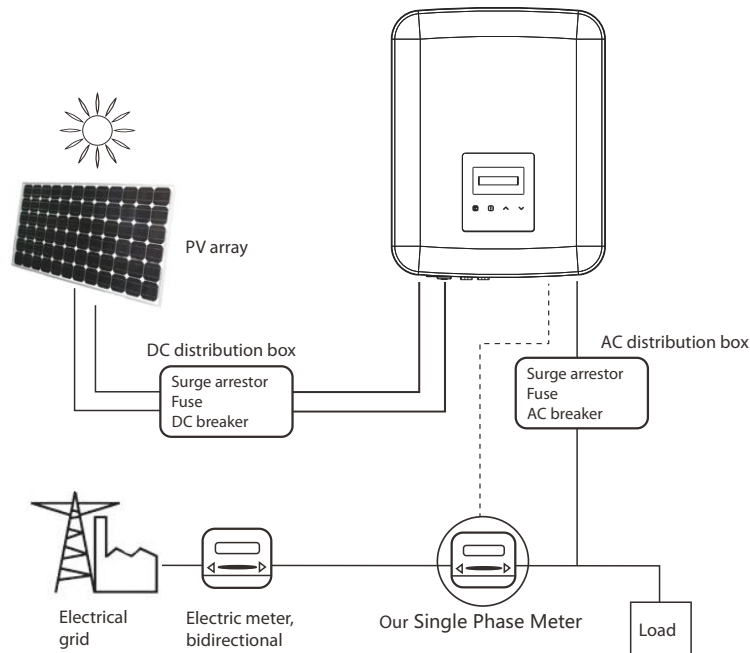

\* Surge protection devices (SPDs) for PV installation

#### WARNING!



- Over-voltage protection with surge arresters should be provided when the PV power system is installed.
- The grid connected inverter is fitted with SPDs in MAINS side.

Lightning will cause a damage either from a direct strike or from surges due to a nearby strike.

Induced surges are the most likely cause of lightning damage in majority or installations, especially in rural areas where electricity is usually provided by long overhead lines. Surge may be included on both the PV array conduction and the AC cables leading to the building.

Specialists in lightning protection should be consulted during the end use application. Using appropriate external lightning protection, the effect of a direct lightning strike into a building can be mitigated in a controlled way, and the lightning current can be discharged into the ground.

Installation of SPDs to protect the inverter against mechanical damage and excessive stress include a surge arrester in case of a building with external lightning protection system (LPS) when separation distance is kept.

To protect the DC system, surge suppression device (SPD type2) should be fitted at the inverter end of the DC cabling and at the array located between the inverter and the PV generator, if the voltage protection level (VP) of the surge arresters is greater than 1100V, an additional SPD type 3 required for surge protection for electrical devices.

To protect the AC system, surge suppression devices (SPD type2) should be fitted at the main incoming point of AC supply (at the consumer's cutout), located between the inverter and the meter/ distribution system; SPD (test impulse D1) for signal line according to EN 61632-1.

All DC cables should be installed to provide as short a run as possible, and positive and negative cables of the string or main DC supply should be bundled together. Avoid creating loops in the system. This requirement for short runs and bundling includes any associated earth bundling conductors.

Spark gap devices are not suitable to be used in DC circuits once conducting, they won't stop conducting until the voltage passes through their terminals typically less than 30 volts.

#### Anti-Islanding Effect

Islanding effect is a special phenomenon that grid-connected PV system still supply power to the nearby grid when electrical grid power is no longer present. It is dangerous for maintenance personnel and the public.

X1 series provide Active Frequency Drift(AFD) to prevent islanding effect.

## 2.2 Important Safety Instructions



**DANGER!**  
Danger to life due to high voltages in the inverter!

- All work must be carried out by qualified electrician.
- The appliance is not to be used by children or persons with reduced physical sensory or mental capabilities, or lack of experience and knowledge, unless they have been given supervision or instruction.
- Children should be supervised to ensure that they do not play with the appliance.



**CAUTION!**  
Danger of burn injuries due to hot enclosure parts!

- During operation, the upper lid of the enclosure and the enclosure body may become hot.
- Only touch the lower enclosure lid during operation.



**CAUTION!**  
Possible damage to health as a result of the effects of radiation!

- Do not stay closer than 20 cm to inverter for any length of time.



**NOTE!**  
Grounding the PV generator.

- Comply with the local requirements for grounding the PV modules and the PV generator. We recommend connecting the generator frame and other electrically conductive surfaces in a manner which ensures continuous conduction and grounding these in order to have optimal protection of system and persons.



**WARNING!**

- Ensure input DC voltage  $\leq$  Max. DC voltage. Over voltage may cause permanent damage to inverter or other losses, which will not be included in warranty!



**WARNING!**

- Authorized service personnel must disconnect both AC and DC power from X1 series before attempting any maintenance or cleaning or working on any circuits connected to the X1 series.



**WARNING!**  
Do not operate the inverter when the device is running.



**WARNING!**  
Risk of electric shock!

- Prior to the application, please read this section carefully to ensure correct and safe application. Please keep the user manual properly.
- Use only attachments recommended or sold by US. Otherwise may result in a risk of fire, electric shock, or injury to person.
- Make sure that existing wiring is in good condition and that wire is not undersized.
- Do not disassemble any parts of inverter which are not mentioned in installation guide. It contains no user-serviceable parts. See Warranty for instructions on obtaining service. Attempting to service the X1 Series inverter yourself may result in a risk of electric shock or fire and will void your warranty. Keep away from flammable, explosive materials to avoid fire disaster.
- The installation place should be away from humid or corrosive substance.
- Authorized service personnel must use insulated tools when installing or working with this equipment.
- PV modules shall have an IEC 61730 class A rating.
- Never touch either the positive or negative pole of PV connecting device. Strictly prohibit touching both of them at the same time.
- The unit contains capacitors that remain charged to a potentially lethal voltage after the MAINS and PV supply has been disconnected.



**WARNING!**  
Hazardous voltage will present for up to 5 minutes after disconnection from power supply.

- CAUTION-RISK of electric shock from energy stored in capacitor. Never operate on the solar inverter couplers, The MAINS cables, PV cables or the PV generator when power is applied. After switching off the PV and Mains, always wait for 5 minutes to let the intermediate circuit capacitors discharge before you unplug DC and MAINS couplers.
- When accessing the internal circuit of solar inverter, it is very important to wait 5 minutes before operating the power circuit or demounting the electrolyte capacitors inside the device. Do not open the device beforehand since the capacitors require time to sufficiently discharge!
- Measure the voltage between terminals UDC+ and UDC- with a multi-meter (impedance at least 1Mohm) to ensure that the device has totally discharged.

### PE Connection and Leakage Current

- The inverter incorporates a certified internal Residual Current Device (RCD) in order to protect against possible electrocution and fire hazard in case of a malfunction in the cables or the inverter. There are two trip thresholds for the RCD as required for certification (IEC 62109-2: 2011). The default value for electrocution protection is 30 mA, and for slow rising current is 300 mA.
- If an external RCD is required by local regulations, check which type of RCD is required for relevant electric code. It recommends using a type-A RCD. The recommended RCD value is 100 mA unless a lower value is required by the specific local electric codes.

The device is intended to connect to a PV generator with a capacitance limit of approx 700nf.

	<p><b>WARNING !</b></p> <ul style="list-style-type: none"> <li>• High leakage current!</li> <li>• Earth connection essential before connecting supply.</li> </ul>
---	---

- Incorrect grounding can cause physical injury, death or equipment malfunction and increase electromagnetic.
- Make sure that grounding conductor is adequately sized as required by safety regulations.

#### For United Kingdom

- The installation that connects the equipment to the supply terminals shall comply with the requirements of BS 7671.
- Electrical installation of PV system shall comply with requirements of BS 7671 and IEC 60364-7-712.
- No protection settings can be altered.
- Installer shall ensure that equipment is so installed and operated to maintain at all times compliance with the requirements of ESQCR22(1)(a).



#### For Australia and New Zealand

- Electrical installation and maintenance shall be conducted by licensed electrician and shall comply with Australia National Wiring Rules.











### 2.3 Explanation of Symbols

This section gives an explanation of all the symbols shown on the inverter and on the type label.

#### • Symbols on the Inverter

Symbol	Explanation
	The inverter is working normally, when the blue light is on.
	An error has occurred, when the red light is on.

#### • Symbols on the Type Label

Symbol	Explanation
	CE mark. The inverter complies with the requirements of the applicable CE guidelines.
	Compliant with UKCA standards.
	RCM remark.
	TUV certification.
	Beware of hot surface. The inverter can become hot during operation. Avoid contact during operation.
	Danger of high voltages. Danger to life due to high voltages in the inverter!
	Danger. Risk of electric shock!
	Observe enclosed documentation.
	The inverter can not be disposed together with the household waste. Disposal information can be found in the enclosed documentation.
	Do not operate this inverter until it is isolated from mains and on-site PV generation suppliers.
	Danger to life due to high voltage. There is residual voltage in the inverter which needs 5 min to discharge. • Wait 5 min before you open the upper lid or the DC lid.

### 2.4 EC Directives

This section describes the requirements of the European low voltage regulations, including safety instructions and system licensing conditions, the user must comply with these regulations when installing, operating, and maintaining the inverter, otherwise personal injury or death may occur, and the inverter will be damaged. Please read the manual carefully when operating the inverter. If you do not understand "Danger", "Warning", "Caution" and the description in the manual, please contact the manufacturer or service agent before installing and operating the inverter.

Make sure that the whole system complies with the requirements of EC (2014/35/EU, 2014/30/EU, etc.) before starting the module (i.e. to start the operation).

Standard of 2014/35/EU (LVD)  
 EN IEC 62109-1; EN IEC 62109-2  
 EN 62477-1

Standard of 2014/30/EU (EMC)  
 EN IEC 61000-6-1; EN IEC 61000-6-2;  
 EN IEC 61000-6-3; EN IEC 61000-6-4;  
 EN IEC 61000-3-2; EN 61000-3-3;  
 EN IEC 61000-3-11; EN 61000-3-12  
 EN 55011

The assembly shall be installed in accordance with the statutory wiring rules. Install and configure the system in accordance with safety rules, including the use of specified wiring methods. The installation of the system can only be done by professional assemblers who are familiar with safety requirements and EMC. The assembler shall ensure that the system complies with the relevant national laws. The individual subassembly of the system shall be interconnected by means of the wiring methods outlined in national/international such as the national electric code (NFPA) No. 70 or VDE regulation 4105.

## 3. Introduction

### 3.1 Basic Features

Thanks for your purchasing our inverter. The inverter incorporates advanced technology, high reliability, and convenient control features.

- Advanced DSP control technology.
- Utilize the latest high-efficiency power component.
- Optimal MPPT technology.
  - Two independent MPP Tracking.
  - Wide MPPT input range.
- Advanced anti-islanding solutions.
- IP66 protection level.

- Max. efficiency up to 98%.EU efficiency up to 97%.
- THD<2%.
- Safety &Reliability: transformerless design with software and hardware protection.
- Power factor regulation.
- Friendly HMI.
  - LED status indications.
  - LCD display technical data, Human-machine interaction through press key.
  - Dry contact communication interface.
  - PC remote control.
  - Remote upgrade and upgrade through USB interface.
  - Wi-Fi dongle.
  - LAN/ GPRS monitoring/ Wi-Fi Plus/ GPRS(optional) dongle.
  - Energy conservation.

### 3.2 Terminals of the Inverter

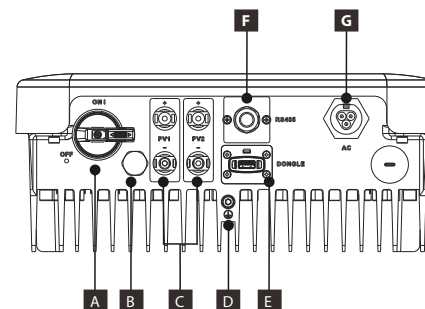

Object	Description
A	DC Switch (optional)
B	Waterproof Lock Valve
C	DC Connector
D	Ground screw
E	Wi-Fi (optional), LAN/ 4G (optional) dongle, UPGRADE
F	RS485/ Meter/ CT/ DRM(optional)
G	AC Connector

Note: Wi-Fi/ LAN/ 4G dongle share one port E; RS485/ Meter/ DRM share one port F.



**WARNING!**  
 Only authorized personnel is allowed to set the connection.



### 3.3 Dimension

#### Dimension

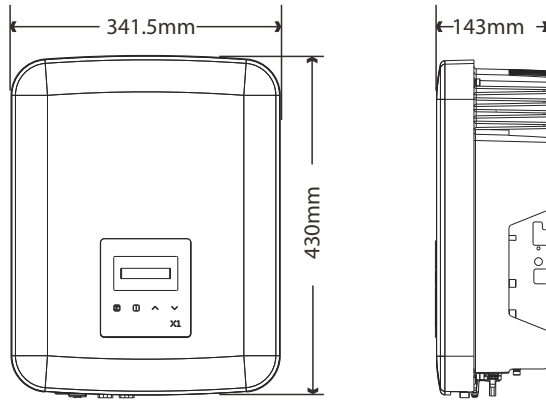

## 4. Technical Data

### 4.1 DC Input

Model	X1-3.0-T-D(L)	X1-3.3-T-D(L)	X1-3.6-T-D(L)	X1-4.2-T-D(L)	X1-4.6-T-D(L)	X1-4.6K-T-D(L)	X1-5.0-T-D(L)	X1-5.0K-T-D(L)	X1-5.5K-T-D(L)	X1-6K-T-D(L)
	X1-3.0-T-N(L)	X1-3.3-T-N(L)	X1-3.6-T-N(L)	X1-4.2-T-N(L)	X1-4.6-T-N(L)	X1-4.6K-T-N(L)	X1-5.0-T-N(L)	X1-5.0K-T-N(L)	X1-5.5K-T-N(L)	X1-6K-T-N(L)
Max. recommended PV array power [W]	4500	4950	5400	6300	6900	6900	7500	7500	8250	9000
Max. PV voltage[d.c.V]	600	600	600	600	600	600	600	600	600	600
MPPT voltage range [d.c.V]	70-580	70-580	70-580	70-580	70-580	70-580	70-580	70-580	70-580	70-580
MPPT voltage range@full load [d.c.V]	115-550	120-550	138-550	177-550	220-550	220-550	192-550	192-550	208-550	230-550
Max. PV current [d.c.A]	14/14	14/14	14/14	14/14	14/14	14/14	14/14	14/14	14/14	14/14
I <sub>sc</sub> PV array Short Circuit Current [d.c.A] ①	18/18	18/18	18/18	18/18	18/18	18/18	18/18	18/18	18/18	18/18
Start output voltage [d.c.V]	100	100	100	100	100	100	100	100	100	100
No. of MPP trackers	2	2	2	2	2	2	2	2	2	2
Strings per MPP tracker	1	1	1	1	1	1	1	1	1	1
Max. inverter backfeed current to the array(mA)	0									
DC disconnection switch	Optional									

① I<sub>sc</sub> PV array Short Circuit current means the maximum short circuit current under the standard temperature 25°C.

### 4.2 AC Output

Model	X1-3.0-T-D(L)	X1-3.3-T-D(L)	X1-3.6-T-D(L)	X1-4.2-T-D(L)	X1-4.6-T-D(L)	X1-4.6K-T-D(L)	X1-5.0-T-D(L)	X1-5.0K-T-D(L)	X1-5.5K-T-D(L)	X1-6K-T-D(L)
	X1-3.0-T-N(L)	X1-3.3-T-N(L)	X1-3.6-T-N(L)	X1-4.2-T-N(L)	X1-4.6-T-N(L)	X1-4.6K-T-N(L)	X1-5.0-T-N(L)	X1-5.0K-T-N(L)	X1-5.5K-T-N(L)	X1-6K-T-N(L)
Rated output apparent power [VA]	3000	3300	3680	4200	4600	4600	5000 <sup>Ⓞ</sup>	4999	5500 <sup>Ⓞ</sup>	6000 <sup>Ⓞ</sup>
Max.apparent AC power[VA]	3300	3630	4048 <sup>Ⓞ</sup>	4620 <sup>Ⓞ</sup>	5060 <sup>Ⓞ</sup>	4600	5500 <sup>Ⓞ</sup>	4999	6050 <sup>Ⓞ</sup>	6600 <sup>Ⓞ</sup>
Nominal AC voltage and range [a.c.V]	220/230/240 (180-280)									
Rated AC frequency and range [Hz]	50(45-55)/60(55-65)									
Rated output current [a.c.A]	13	14.3	16	18.3	20	20	21.7 <sup>Ⓞ</sup>	21.7	23.9 <sup>Ⓞ</sup>	26.1 <sup>Ⓞ</sup>
Max. output continuous current [a.c.A]	14.3	15.8	17.6 <sup>Ⓞ</sup>	20.1 <sup>Ⓞ</sup>	22 <sup>Ⓞ</sup>	20	23.9 <sup>Ⓞ</sup>	21.7	26.3 <sup>Ⓞ</sup>	28.7 <sup>Ⓞ</sup>
Max. output overcurrent protection[a.c.A]	33									
Current (inrush) [a.c.A]	92									
Total harmonic distortion(THDI)	<2%									
Power factor range	0.8 leading-0.8lagging									
Feed in phase	Single-phase									
Over voltage category	III (electric supply side), II (PV side)									
Maximum output fault current [a.c.A]	59 (3 ms)									
Maximum output overcurrent protection [a.c.A]	50									

Ⓞ 3680 for TOR and G98  
 Ⓞ 4600 for VDE4105  
 Ⓞ 16 for TOR and G98  
 Ⓞ 20 for VED4105

Ⓞ 4999W for AS4777; 4600W for VDE4105  
 Ⓞ 4999VA for AS4777; 4600VA for VDE4105  
 Ⓞ 21.7A for AS4777; 20A for VDE4105

### 4.3 Efficiency, Safety and Protection

Model	X1-3.0-T-D(L)	X1-3.3-T-D(L)	X1-3.6-T-D(L)	X1-4.2-T-D(L)	X1-4.6-T-D(L)	X1-4.6K-T-D(L)	X1-5.0-T-D(L)	X1-5.0K-T-D(L)	X1-5.5K-T-D(L)	X1-6K-T-D(L)	
	X1-3.0-T-N(L)	X1-3.3-T-N(L)	X1-3.6-T-N(L)	X1-4.2-T-N(L)	X1-4.6-T-N(L)	X1-4.6K-T-N(L)	X1-5.0-T-N(L)	X1-5.0K-T-N(L)	X1-5.5K-T-N(L)	X1-6K-T-N(L)	
MPPT efficiency	99.90%	99.90%	99.90%	99.90%	99.90%	99.90%	99.90%	99.90%	99.90%	99.90%	
Euro efficiency	97.00%	97.00%	97.00%	97.00%	97.00%	97.00%	97.00%	97.00%	97.00%	97.00%	
Max. efficiency	97.80%	97.80%	97.80%	97.80%	97.80%	97.80%	97.80%	97.80%	97.80%	97.80%	
<b>Safety &amp; Protection</b>											
Over/under voltage protection					YES						
DC isolation protection					YES						
Monitoring ground fault protection					YES						
Grid protection					YES						
DC injection monitoring					YES						
Back feed current monitoring					YES						
Residual current detection					YES						
Anti-islanding protection					YES						
Over load protection					YES						
Over heat protection					YES						

### 4.4 General Data

Model	X1-3.0-T-D(L)	X1-3.3-T-D(L)	X1-3.6-T-D(L)	X1-4.2-T-D(L)	X1-4.6-T-D(L)	X1-4.6K-T-D(L)	X1-5.0-T-D(L)	X1-5.0K-T-D(L)	X1-5.5K-T-D(L)	X1-6K-T-D(L)
	X1-3.0-T-N(L)	X1-3.3-T-N(L)	X1-3.6-T-N(L)	X1-4.2-T-N(L)	X1-4.6-T-N(L)	X1-4.6K-T-N(L)	X1-5.0-T-N(L)	X1-5.0K-T-N(L)	X1-5.5K-T-N(L)	X1-6K-T-N(L)
Dimension [W/H/D](mm)	430*341.5*143									
Dimension of packing [W/H/D](mm)	514*439*233									
Net weight [kg]	13.5	13.5	13.5	15.0	15.0	15.0	15.0	15.0	15.0	15.0
Gross weight [kg]	16.0	16.0	16.0	17.0	17.0	17.0	17.0	17.0	17.0	17.0
Installation	Wall-mounted									
Operating ambient temperature range[°C]	-25~+60 (derating at 45)									
Storage temperature [°C]	-30~+70									
Storage/Operation relative humidity	0%~100%, condensation									
Altitude [m]	≤3000									
Ingress Protection	IP66									
Isolation type	Non-isolated									
Protective Class	I									
Night-time consumption	< 2W									
Overvoltage Category	III (MAINS), II (PV)									
Pollution Degree	II									
Cooling	Natural Cooling									
Noise level	30dB									
Inverter Topology	Non-isolated									
Communication interface	Wi-Fi (optional), LAN/GPRS(optional) dongle/4G/Meter/CT/RS485/ DRM/ USB									
Standard warranty [year]	5 years (10 optional)									
Active anti-islanding method	Frequency shift									
Grid monitoring	AS/NZS4777.2; VDE4105; EN50549; CEI 0-21; G98, G99									

## 5. Installation

### 5.1 Check for Transport Damage

Make sure the inverter is intact during transportation. If there are some visible damages, such as cracks, please contact your dealer immediately.

### 5.2 Packing Lists

Open the package and fetch out the product, check the accessories at first. The packing list shows as below.

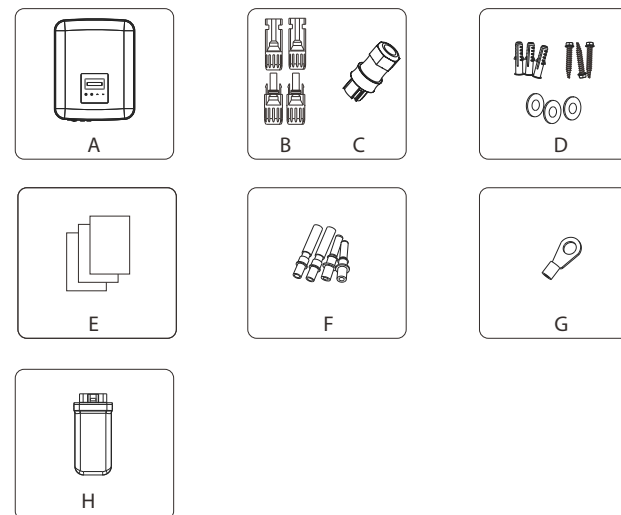

Object	Quantity	Description
A	1	Inverter (with bracket)
B	4	Female DC connector * 2, Male DC connector * 2
C	1	AC connector
D	3	(Expansion bolt, Flat gasket, Self-tapping screw)*3
E	/	Documents
F	4	DC pin contact(2* positive, 2* negative)
G	1	Earth terminal
H	1	Wi-Fi (optional), LAN/GPRS(optional) Dongle

**NOTE!**  
 For the optional accessories, please be subject to the actual delivery.

### 5.3 Installation Precaution

X1 Series inverter is designed for outdoor installation (IP 66). Make sure the installation site meets the following conditions:

- Not be exposed to glare.
- Not in areas where highly flammable materials are stored.
- Not in potential explosive areas.
- Not in the cool air directly.
- Not near the television antenna or antenna cable.
- Not higher than altitude of about 3000 m above sea level.
- Not in environment of precipitation or humidity(100%) .
- Be sure the ventilation is good enough.
- The ambient temperature in the range of -25°C to +60°C.  
The slope of the wall should be within  $\pm 5^\circ$ .
- The wall hanging the inverter should meet conditions below:
  - 1) Solid brick/concrete, or strength equivalent mounting surface;
  - 2) Inverter must be supported or strengthened if the wall's strength isn't enough (Such as wooden wall, the wall covered by thick layer of decoration)

Please avoid direct sunlight, rain exposure, snow laying up during installing and operating.

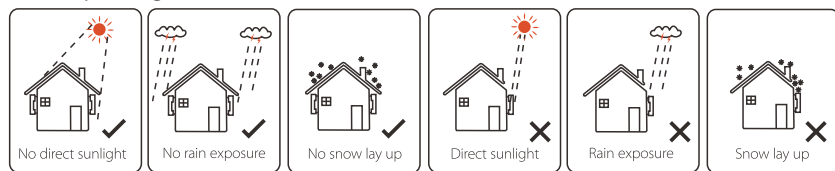

#### Available Space Size

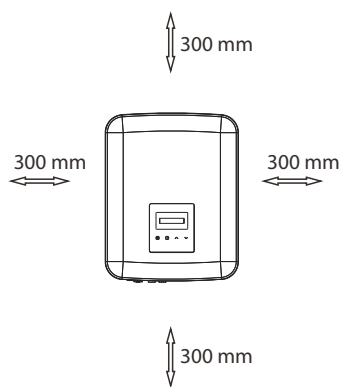

Table Available Space Size

Position	Min.size
Left	300 mm
Right	300 mm
Top	300 mm
Bottom	300 mm
Front	300 mm

### 5.4 Installation Steps

#### Preparation

Below tools are needed before installation.



Installation tools : crimping pliers for binding post, screwdriver, manual wrench,  $\Phi 10$  driller and torque wrench.

Step 1: Unscrew the bracket from the back of the inverter.

a) The wall bracket is fixed on the inverter, and the user should remove it firstly. (Phillips screwdriver,  $\Phi 10$  driller. torque:  $0.8 \pm 0.1 \text{N}\cdot\text{m}$ )

#### Step 2: Screw the wall bracket on the wall

- b) Use the wall bracket as a template to mark the position of the 3 holes on the wall.
- c) Drill holes with driller, make sure the holes are deep enough (at least 60mm) for installation.
- d) Install the expansion tubes in the holes, use the torque wrench to tighten self-tapping screws. Then install the wall bracket by using the expansion screws.

#### Step 3: Match the inverter with wall bracket

e) Hang the inverter over the bracket, move the inverter close to it, slightly lay down the inverter, and make sure the 2 mounting bars on the back are fixed well with the 2 grooves on the bracket.

Note: Please refer to the details from the Quick Installation Guide.

### 5.5 Connections of the Inverter

#### 5.5.1 The Main Steps to Connect to the Inverter

##### PV String Connection

The inverter has a couple of PV connectors which can be connected in series into 2-strings PV modules. Please select PV modules with excellent function and reliable quality. Open circuit voltage of module array connected should be  $< \text{Max.DC}$  (table as follow) input voltage, and operating voltage should be within the MPPT voltage range.

Table 3 Max. DC Voltage Limitation

Model	X1-3.0-T-D(L)	X1-3.3-T-D(L)	X1-3.6-T-D(L)	X1-4.2-T-D(L)	X1-4.6-T-D(L)	X1-4.6K-T-D(L)	X1-5.0-T-D(L)	X1-5.0K-T-D(L)	X1-5.5K-T-D(L)	X1-6K-T-D(L)
	X1-3.0-T-N(L)	X1-3.3-T-N(L)	X1-3.6-T-N(L)	X1-4.2-T-N(L)	X1-4.6-T-N(L)	X1-4.6K-T-N(L)	X1-5.0-T-N(L)	X1-5.0K-T-N(L)	X1-5.5K-T-N(L)	X1-6K-T-N(L)
Max.DC Voltage	600V									

**DANGER!**  
 Danger to life due to high voltages on DC conductors.  
 · When exposed to sunlight, the PV array generates dangerous DC voltage which is present in the DC conductors. Touching the DC conductors can lead to lethal electric shocks.  
 · Cover the PV modules.  
 · Do not touch the DC conductors.

**NOTE!**  
 Please choose a suitable external DC switch if the model (X1-3.0-T-N(L), X1-3.3-T-N(L), X1-3.6-T-N(L), X1-4.2-T-N(L), X1-4.6-T-N(L), X1-4.6K-T-N(L), X1-5.0-T-N(L), X1-5.0K-T-N(L), X1-5.5K-T-N(L), X1-6K-T-N(L)) is purchased.

**WARNING!**  
 PV module voltage is very high which belongs to dangerous voltage range, please comply with the electric safety rules when connecting.

**WARNING!**  
 Please do not make PV positive or negative ground!

**NOTE!**  
 Please follow the requirements of PV modules as below:  
 · Same type; Same quantity; Identical alignment; Identical tilt.  
 · In order to save cable and reduce the DC loss, we suggest installing the inverter near PV modules.

• Connection Steps

Below tools are needed before connection.



Stripping pliers      Wire crimper

Wire crimper recommended model : H4TC0001  
 manufacturer: Amphenol

a) Turn off the DC switch, then Choose 4mm<sup>2</sup> wire to connect the PV module.

b) Strip 7mm of insulation from the wire end by using the stripping pliers.

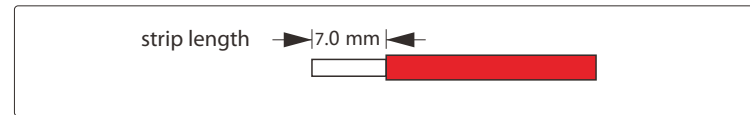

c) Insert striped wire into pin contact and ensure all conductor strand are captured in the pin contact.



d) Crimp pin contact by using the wire crimper.

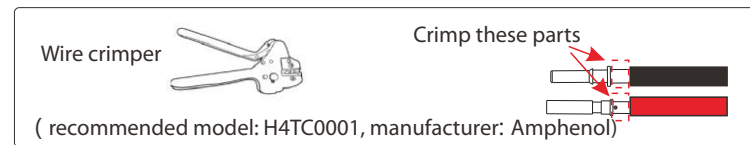

e) Separate the DC connector as two parts: the plug and the cable nut. Then insert the wire with pin contact through the cable nut.

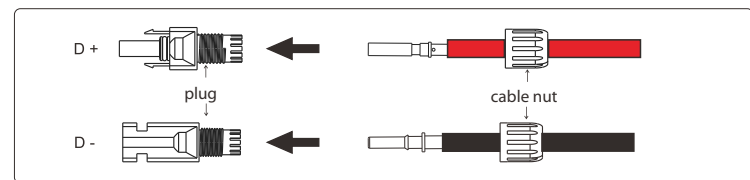

f) Insert the wire into plug forcibly, when a "click" is heard or felt the pin contact assembly is seated correctly. Then tighten the cable nut.

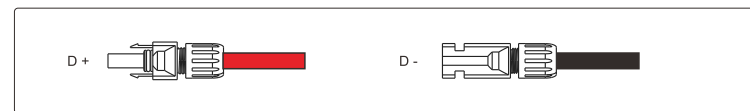

g) Use a multimeter to measure whether the positive and negative and check whether this PV module is normal.

h) Remove the blue protective cover of the PV +&- interface at the bottom of the inverter, and insert the completed PV terminals according to the positive and negative correspondence.

i) Cover the remaining unused PV terminals with the original blue cover

j) Keep the DC switch of the inverter off (if there is a DC switch)

**Grid Connection**

X1 series inverter are designed for single phase grid. Nominal grid voltage is 220/ 230/ 240 V, frequency is 50/ 60 Hz. Other technical requests should comply with the requirement of the local public grid.

Table 4 Cable and Micro-breaker recommended

Model	X1-3.0-T-D(L)	X1-3.3-T-D(L)	X1-3.6-T-D(L)	X1-4.2-T-D(L)	X1-4.6-T-D(L)	X1-4.6K-T-D(L)	X1-5.0-T-D(L)	X1-5.0K-T-D(L)	X1-5.5K-T-D(L)	X1-6K-T-D(L)
	X1-3.0-T-N(L)	X1-3.3-T-N(L)	X1-3.6-T-N(L)	X1-4.2-T-N(L)	X1-4.6-T-N(L)	X1-4.6K-T-N(L)	X1-5.0-T-N(L)	X1-5.0K-T-N(L)	X1-5.5K-T-N(L)	X1-6K-T-N(L)
LN Cable	4-6 mm <sup>2</sup>	4-6 mm <sup>2</sup>	4-6 mm <sup>2</sup>	5-6 mm <sup>2</sup>	5-6 mm <sup>2</sup>	5-6 mm <sup>2</sup>	5-6 mm <sup>2</sup>	5-6 mm <sup>2</sup>	5-6 mm <sup>2</sup>	5-6 mm <sup>2</sup>
PE Cable	2.5-6 mm <sup>2</sup>	2.5-6 mm <sup>2</sup>	2.5-6 mm <sup>2</sup>	2.5-6 mm <sup>2</sup>	2.5-6 mm <sup>2</sup>	2.5-6 mm <sup>2</sup>	2.5-6 mm <sup>2</sup>	2.5-6 mm <sup>2</sup>	2.5-6 mm <sup>2</sup>	2.5-6 mm <sup>2</sup>
Micro-breaker	20 A	20 A	20 A	25 A	25 A	25 A	32 A	32 A	32 A	32 A

\*The parameters vary because of different environment and material. Please choose appropriate cable and micro-breaker according to the local conditions .

**NOTE!** Inverters should not be used in multiple phase combinations.

Micro-breaker should be installed between inverter and grid, any loads should not be connected with inverter directly.

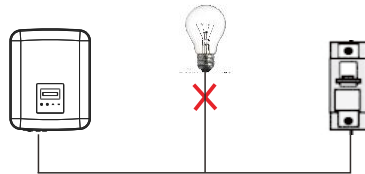

**Incorrect Connection between Load and Inverter**

• Connection Steps

- a) Check the grid voltage and compare with the permissive voltage range ( refer to technical data).
- b) Disconnect the circuit-breaker from all the phases and secure against re-connection.
- c) Strip the wires:
  - Strip all the wires to 52.5mm and the PE wire to 55mm.
  - Use the crimping pliers to strip 6mm of insulation from all wire ends as below.

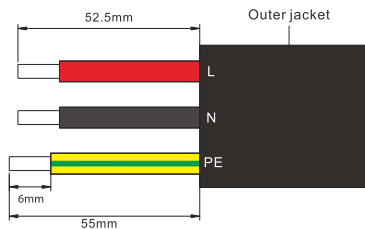

- d) Separate the AC plug into three parts as below.
  - Hold the middle part of the female insert, rotate the back shell to loose it, and detach it from female inset.
  - Remove the cable nut (with rubber insert) from the back shell.

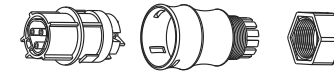

- e) Slide the cable nut and then back shell onto the cable.

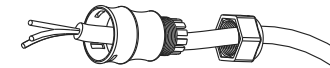

- f) Insert the stripped end of each three wires into the appropriate hole in the female insert, and then tight each screw (to tight each wire in place). (Ph1 cross screwdriver. Torque: 0.5±0.1N.m)

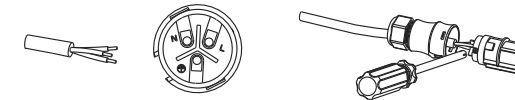

- g) Screw down the threaded sleeve the pressure screw.

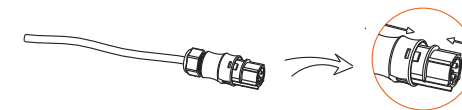

- h) Screw down the pressure screw. (torque: 3±0.3N.m)

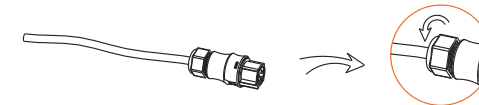

- l) Connect the AC plug to the inverter.

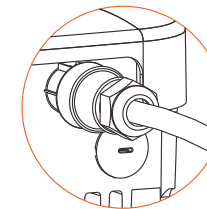

### Selection of Fuses and Cables connection

Mini cable(AC line cable)shall be short circuit protected and thermal overload protected.

Always fit the input cable with fuse. Normal gGs (US: CC or T ) fuses will protect the input cable in short circuit situation. They will also prevent damage to adjoining equipment. Dimension the fuses according to local safety regulations, appropriate input voltage and the related current of the solar inverter.

AC output protected by external fuse (gG rated current 25 A/ 250 VAC for 3.0 KW/ 3.3 KW; 32 A/ 250 VAC for 3.6 KW/ 4.2 KW/ 4.6 KW/ 5.0 KW/ 5.5 KW/ 6.0 KW) provides in all live connections to the AC supply.

The rated short circuit breaking capacity of the above protective device shall be at least equal to the prospective fault current at the point of installation. See section technical data of this manual details.

AC output cable: Cu; L, N,PE: 3\*4.0 mmfor 3.0 KW/ 3.3 KW/ 3.6 KW and 3\*5 mm for 4.2 KW/ 4.6 KW/ 5.0 KW/ 5.5 KW/ 6.0 KW @40°C ambient temperature with a max length of 5 m, with operating time of the fuses is less than 5 seconds, installation method B2 according to EN60204-1:2006, annex D: cable in conduit cable trunking system, number of loaded circuit only one. Use H07RNF(cord designation 60245 IEC66) for anambient temperature of 40°C or less and use 90°C wire for ambient temperature between 40°C and 60°C.

Note 1: For conditions differing from those mentioned above, dimension the cables according to local safety regulations, appropriate input voltage and the load and the load current of the unit.(You can choose a thicker cable but the fuses must rated according to the rating of the cable.)

Note 2: Fuses must be approved by Notiöed Body.

Inverter is not provided galvanic isolation from the mains to the PV array, feedback current to the array is 25A/ 250 VAC for 3.0 KW and 3.3 KW; 32A/ 250 VAC for 3.6 KW,4.2 KW, 4.6 KW, 5.0 KW, 5.5 KW and 6.0 KW based on the fuse provided in the mains. Also in the worst case the reverse current comprises the sum of the short-circuit currents of all intact lines. Therefore the current-carrying capacity of the components and subassemblies provided in the end-use system(connectors, cables, junction box, switch ger, etc. ) and the reverse current PV modules shall be considered based on the feedback current and reverse current. The direct current(DC) circuit breaker or fuse between each solar generator and inverter shall be provided based on solar inverter input ratings. Select DC cables based in the above inverter back-feed current and ISCPV rating and Vmax ratings.

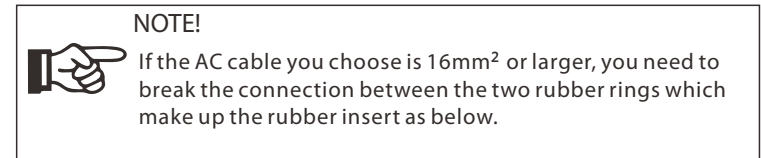

### Earth Connection

Screw the ground screw with allen wrench shown as follow. (φ4 hexagon wrench.torque: 1.5±0.2N.m)

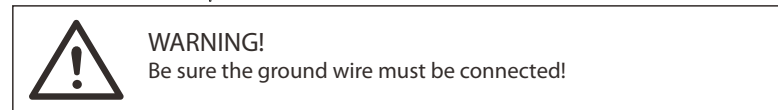
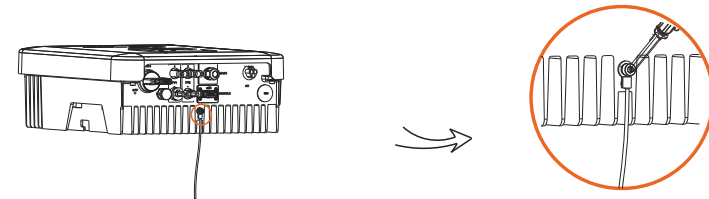

### 5.5.2 Communication interface

This product has a series of communication interfaces: such as Wi-Fi, RS485/ Meter/ DRM are used for communication and USB is used for Firmware updating. Operating information like output voltage, current, frequency, faulty information, etc., can be delivered to PC or other monitoring equipment via these interfaces.

#### ① Wi-Fi

This inverter provides a Wi-Fi port which can collect information from inverter including status, performance and updating information to monitoring website via connecting Wi-Fi dongle (optional).

#### Connection steps:

- 1). Insert the Wi-Fi dongle (optional) into "DONGLE" port at the bottom of inverter.
- 2). Connect Wi-Fi dongle (optional) with the router (see Wi-Fi Setup Guide for details).
- 3). Set power station information on our website.

② RS485/Meter/CT/DRM

a. RS485

RS485 is one standard communication interface which can transmit the realtime data from inverter to PC or other monitoring equipments.

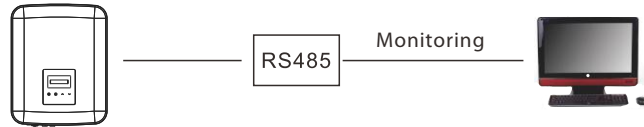

b. Meter/CT(optional)

Note!

It is recommended to connect a Smart meter to inverter. If there is no smart meter installed, please disable the "Export Control" function in the inverter setting otherwise the inverter will stop and report a "Meter fault" alert.



The smart meter must be purchased from and authorized by US, any third party or non-authorized meter may not match with the inverter. We will not take the responsibility if the meter is unavailable or incompatible in this case.

With this single phase meter working together with the X1 series, you can:

- (1) Monitor the energy to grid and from grid through the whole day.
- (2) Achieve the export control function with a higher accuracy.

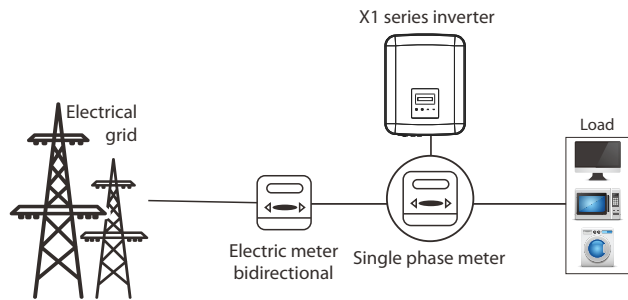

The PIN definitions of RS485/Meter interface are as below.

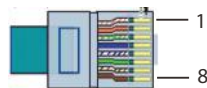

PIN	1	2	3	4	5	6	7	8
Definition	X	Com/DRM0	GND_COM	Meter_A/ 485_A	Meter_B/ 485_B	E_Stop	RefGen	X

c. Parallel connection

The series inverter provides the parallel connection function, which could support several inverters to parallel in one system and can control zero injection to the grid with a meter installed in the main circuit.

Diagram A: Parallel system with Modbus Function

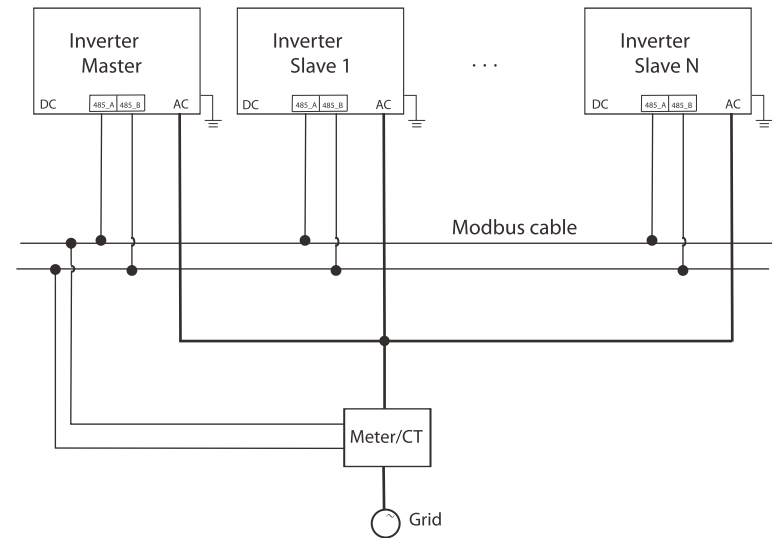

➤ Parallel system with Modbus Function

In this parallel system, at most 5 inverters can be connected. One inverter will be set as a master, and the rest are the slaves. The master inverter can communicate with all the slave inverters.

• Wiring operation

- a) Connect all the inverters in the parallel system with each other via RS485 cables.
- b) Connect the communication cable with the master inverter.

• Setting

Turn on the power of the entire system, enter setting page of the inverters on the LCD screen. Follow the instructions below to finish the settings.

To set the master inverter:

- a) Enter "ParallelSetting" page, choose "Enable" to activate the function for the inverter.

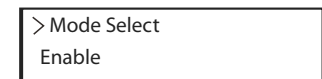
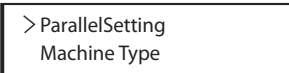

b) Make sure the meter/CT is connected to the master inverter. Enter the "Export Control" page and choose "CT" on the master inverter.



c) Choose "M/S Mode" to select the Master inverter. Only one inverter can be set as "Master".

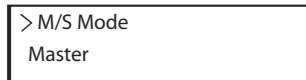

d) Set the value for "Parallel Power" on the master inverter. This will be the overall power limit for parallel system. The output power of slaves will then be distributed respectively according to their nominal output power. The value can be set within the range of 0 kW to 30 kW and the default value is 0 W.

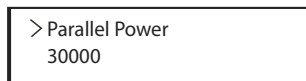

To set the slave inverters:

a) Enter "Setting" page, and choose "ParallelSetting".

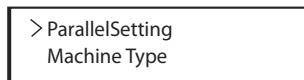

b) Set the status of "Mode Select" as "Enable".

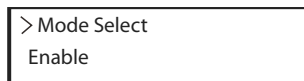

c) Enter "M/S Mode" and chose "Slave" to set the Slave inverters.

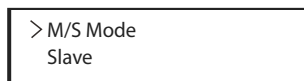

**NOTE!**  
 The power limit value set in "Parallel Power" is the limit for the multiple inverters in the parallel system, while the "UserValue" set in "Export Control" is the power limit for a single inverter which will be nullified when the parallel function is enabled.

d. CT Connection:

The current sensor measures the current on the phase wire that runs between the inverter and the grid.

• CT connection diagram

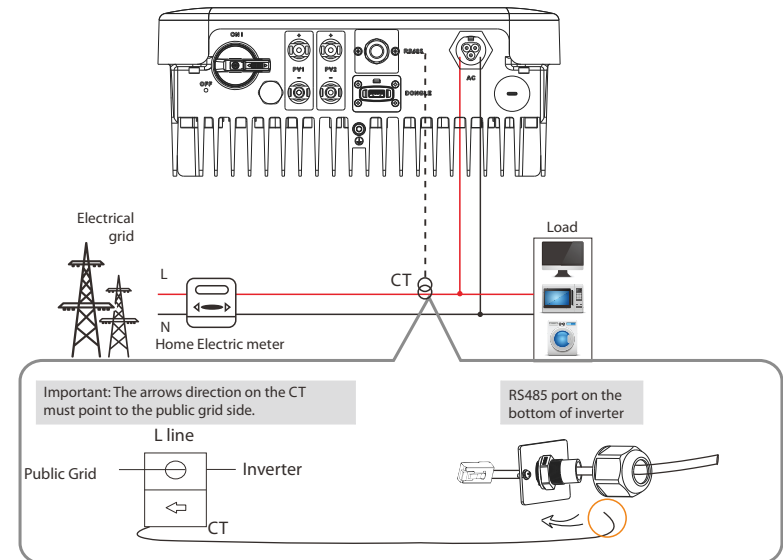



• CT PIN Definition

When connecting the RJ45 connector with the wire of the CT, please follow the sequence below :

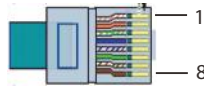

PIN	1	2	3	4	5	6	7	8
Definition	CT+	X	X	X	X	X	X	CT-

• CT Connection Steps:

**NOTE!**

- Do not place the CT on the N Wire or the earth wire.
- Do not place the CT on the N and L wire simultaneously.
- Do not place the CT with the arrow pointing to the inverter side.
- Do not place the CT on the non-insulated wires.
- Do not use the wire over 25m.

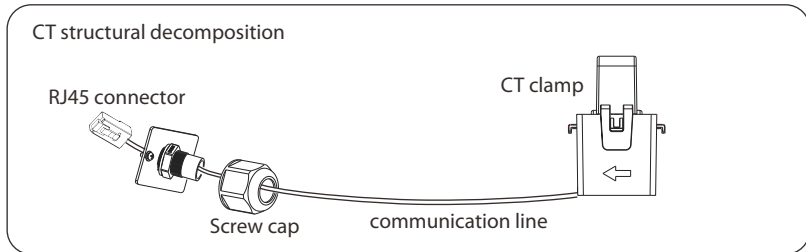

1. Insert the RJ45 connector of CT into the RS485 port on the inverter, and screw down the screw cap tightly.
2. Clip the CT clamp on L line from the home main meter box side.
3. Make sure the current sensor is installed in the right direction: The arrow on the current sensor must point to the public grid.

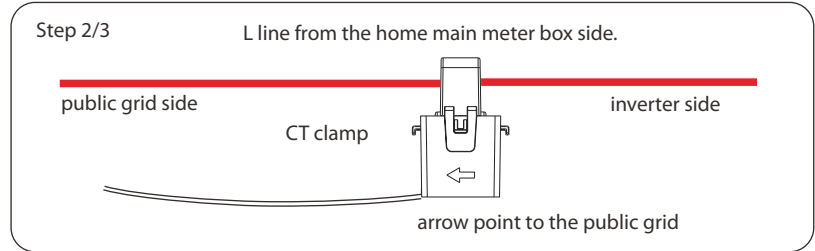
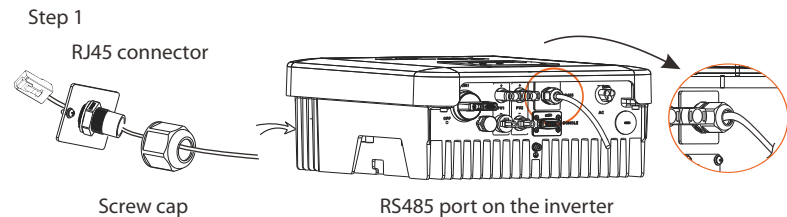

RS485 Connection Steps:

- 1) Firstly unscrew all screws from the RS485 port. (PH1 cross screwdriver . torque:1.0±0.1N.m)
- 2) Prepare a communication cable and trip the insulation from it.
- 3) Let the communication cable pass through the waterproof connector, then insert it into the connector following the PIN definition rule.

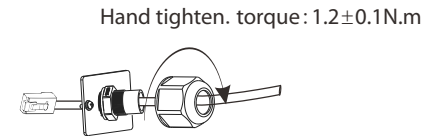

- 4) Crimp the connector with the crimping plier.
- 5) Insert the cable into the RS485 port of the inverter, and tighten the waterproof connector.

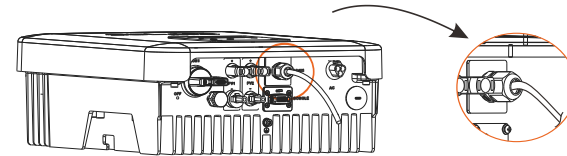

e. DRM

DRM function (for AS4777) is provided to support several demand response modes by giving control signals as below. The user should short circuit between 2 and 7 and cooperate with external equipment when using it.

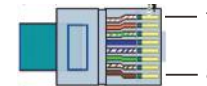

PIN	1	2	3	4	5	6	7	8
Definition	X	Com/DRM0	GND_COM	X	X	X	RefGen	X

DRM shares the terminal block with RS485/ Meter communications. The connection steps of the DRM, user can refer to the above (b) RS485 connections.

Note: Only DRM0 is available now, and other functions are being developed.

③ Upgrade

User can update the inverter system through the U-disk.

**WARNING!**  
 Make sure the input voltage is more than 100V( in good illumination condition), or it may result in failing during updating.

Upgrade Steps:

1) Please contact our service to get the latest firmware. Then add a new folder named "Update" in the root directory on your U-disk, and two more sub-folders named "ARM" and "DSP" under "Update". Please copy the firmware files into ARM and DSP respectively. It will be like:

"Update\ARM\618.00207.00\_XX\_XXXXX\_XXXX\_XXX\_ARM\_Vx.xx\_xxxxxxxxxx.usb";  
 "Update\DSP\618.00381.00\_XX\_XXXXX\_XXXX\_XXX\_DSP\_Vx.xx\_xxxxxxxxxx.usb"

**WARNING!**

- Make sure the directory is in accordance with above form strictly!
- Do not modify the program file name! Or it may cause the inverter does not work anymore!

2) Please insert the U-disk into the "DONGLE" port.

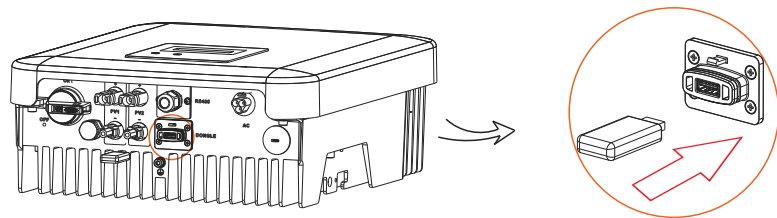

3) Then insert U-disk into the DONGLE port on the bottom of the inverter. Then turn on DC switch or connect the PV connector, the LCD will show the main pictures as below.

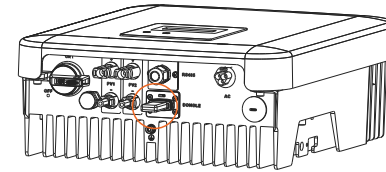

4) Press up and down to select the one that you want to update and long press down to confirm.

5) When the upgrade is completed, please remember to turn off the DC switch and AC switch, then pull off the U-disk.

**WARNING!**  
 During updating, please don't turn off the DC switch or disconnect the PV connector. If failed, please repeat the above operation again.

④ Isolation Fault Alarm

The inverter has the isolation fault alarm function as required by AS 4777.2 and AS/NZS 5033. It will give an visual alarm, you will see that the red light is flickering and the Isolation Fault will show on the LCD of inverter once the Insulation impedance of the PV arrays is less than 100 K.

5.6 Run the Inverter

**Start inverter after checking all below steps:**

- a) Check that device is fixed well on the wall.
- b) Make sure all the DC breakers and AC breakers are disconnected.
- c) AC cable is connected to grid correctly.
- d) All PV panels are connected to inverter correctly, DC connectors which are not used should be sealed by cover.
- e) Turn on the external AC and DC connectors.
- f) Turn on the DC switch to the "ON" position.

**Start the inverter**

- Inverter will start automatically when PV panels generate enough energy.
- Check the status of LED indicators and LCD screen, the LED indicators should be blue and the LCD screen should display the main interface.
- If the LED indication is not blue, please check the below:
  - All the connections are right.
  - All the external disconnect switches are closed.
  - The DC switch of the inverter is in the "ON" position.

The following is the three status when operating, which means inverter starting up successfully.

**Waiting:** Inverter is waiting to checking when DC input voltage from panels is greater than 80 V (lowest start-up voltage) but less than 100 V (lowest operating voltage).

**Checking:** Inverter will check DC input environment automatically when DC input voltage from the PV panels exceeds 100 V and PV panels have enough energy to start inverter.

**Normal:** Inverter begins to operate normally with blue light on. Meanwhile feedback energy to grid, LCD displays present output power.

Enter the setting interface to follow the instructions when it is first time to start up.



**WARNING!**  
Power to the unit must be turned on only after installation work has been completed. All electrical connections must be carried out by qualified personnel in a cordance with legislation in force in the country concerned.



**NOTE!**  
Please set the inverter if it is the first time to start up. Above steps are for the regular start of the inverter. If it is the first time to start up the inverter, you need to setup the inverter.



**ENERGY CONTROL**  
Equipment only to be used for the purpose outlined by us.

## 6. Operation Method

### 6.1 Control panel

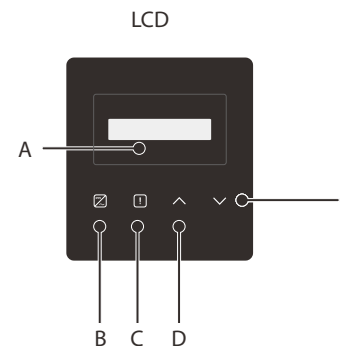

Object	Name	Description
A	LCD Screen	Display the information of the inverter.
B	LED Indicator	Light in blue: The inverter is in normal status. Flash in blue: The inverter is in waiting status.
C		Light in red: The inverter is in fault status.
D	Function Button	Up/ESC button: Move cursor to upside or increase value. Return from current interface or function
E		Down/Enter button: Move cursor to downside or decrease value. Confrm and change the parameters.

Note: The inverter is in "Waiting" and "Checking" status, the blue light "B" is flickering; when in "Normal" status, the blue light "B" is always on.

### 6.2 LCD Structure

Please refer to the inverter for the most updated structure

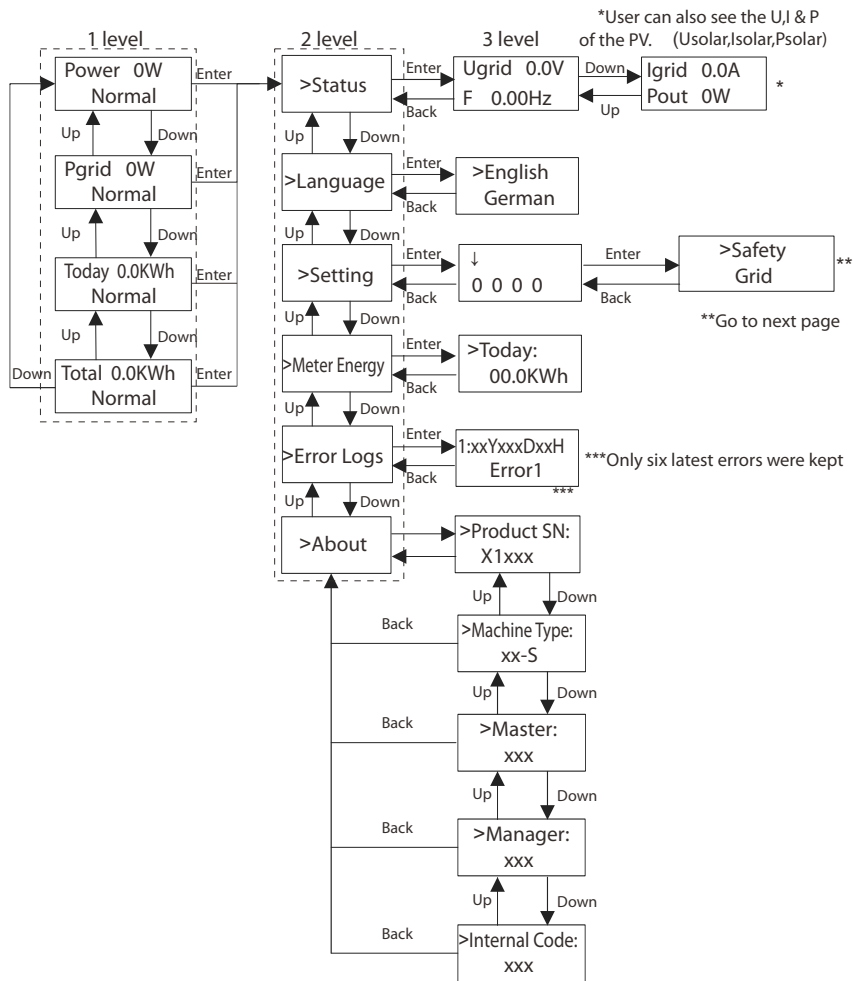

Note:

Key	Operation	Description
Enter/Down	Long Press	Go to the next menu or confirm to change parameters
	Short Press	Look at the next parameter or increase the value
Back/Up	Long Press	Return the previous menu or confirm the parameters
	Short Press	Look at the previous parameter or decrease the value

### 6.3 LCD Operation

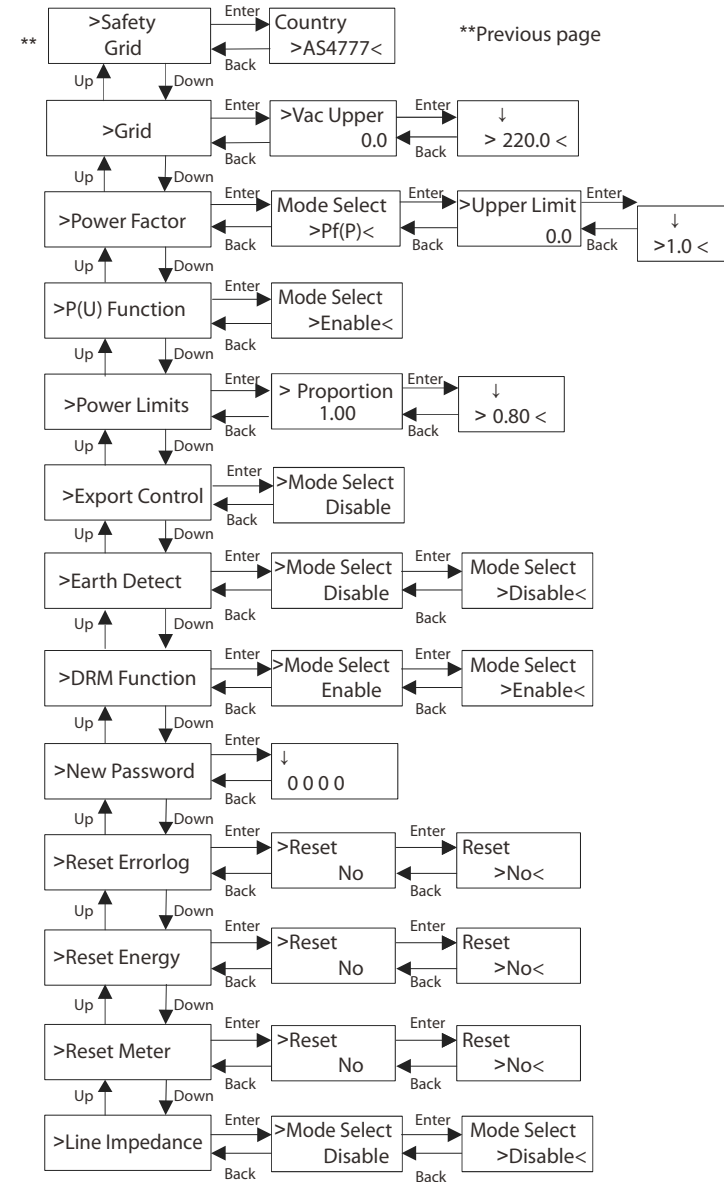

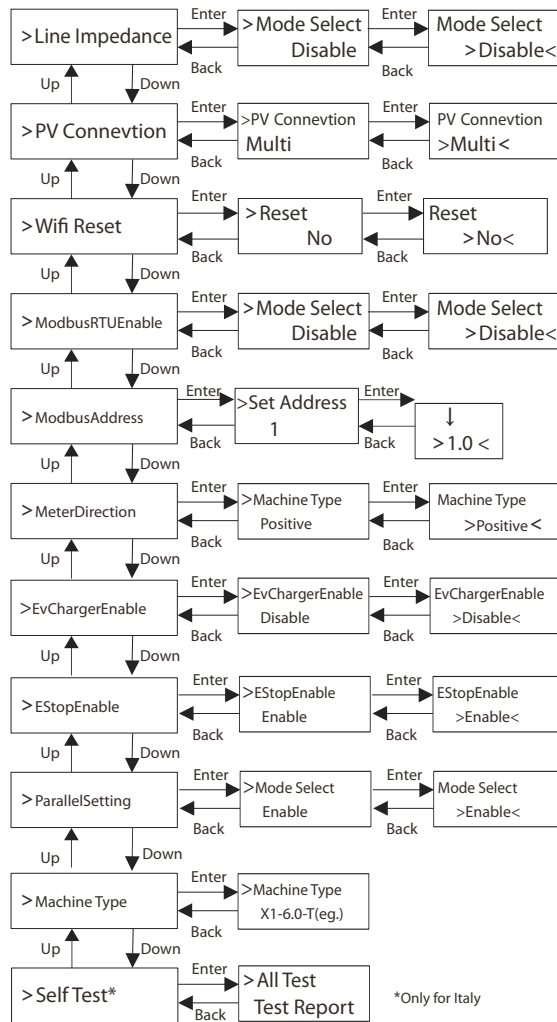

**LCD Display**

• 1 level

- a) The first line displays the parameters(Power, Today and Total) and the values.
- b) The second line shows the running status.

The information of the interface is as below. "Power" means the timely output power; "Pgrid" means the power exported to or imported from the grid. "Today" means the energy generated within the day. "Normal" shows the status of the inverter.(Positive value means the energy fed into the grid, negative value means the energy used from the grid).

2 level

Long press any first-level parameter can enter the second-level "Status" parameter interface.

The user can also see other parameters, such as the Language (without password), Setting (need password ), Meter energy, Error Logs of the inverter, and About ( the user can watch the information of the inverter).

3 level

Long press the second-level parameter can enter the corresponding third-level parameter interface.

a) Status: The user can see the U/I/P parameters of the grid and the PV, such as the Ugrid, Igrid, PF value of the grid, and the Usolar, Isolar and Psolar of the PV.

b) Language: This inverter provides several languages for customer to choose.

c) Setting: Entering the installer password, the information of the LCD interface is as the previous page shown.

(1) Safety: The user can set the right safety standard here.

(2) Grid: Usually end user does not need to set the grid parameters. All default values have been set before leaving factory according to safety rules.

If you need to reset, any changes should refer to the requirement of local grid.

Parameter	Comment
Normally	
Vac upper	Voltage high protect
Vac lower	Voltage low protect
Vac upper slow	Voltage high slow protect
Vac lower slow	Voltage low slow protect
Fac upper	Frequency high protect
Fac lower	Frequency low protect
Fac upper slow	Frequency high slow protect
Fac lower slow	Frequency low slow protect
Vac 10m avg	10 min voltage high protect
Apply to EN50549_NL.	
FreqSetPoint	Frequency set point
FreqDropRate	Frequency droop rate

Parameter	Comment
Apply to EN50549_PL.	
Vac upper	Voltage high protect
T-Start	60s
H/LVRT Function	Disable
FreqSetPoint	Frequency set point
FreqDropRate	Frequency droop rate

(3) Power Factor: ( For specific country if required by the local grid supplier.)  
 There are 6 modes for selecting: Off , Under-Excited, Over-Excited, PF(p), Q( u ).  
 All parameters are shown below.

Mode	Comment
Off	-
Under-Excited	PF value
Over-Excited	PF value
PF(p)	Upper limit
	Lower limit
	Power Upper
	Power Lower
Q( u )	QuVupRate ( EN50549_NL )
	QuVlowRate ( EN50549_NL )
	QUrangV1 ( AS4777.2 )
	QUrangV4 ( AS4777.2 )
Fixed Q Power	Q Power( for some local grids )

For VDE ARN 4105, curve  $\cos\phi=f(P)$  should refer to curve A. Default values of setting are as shown in curve A.  
 For E 8001, curve  $\cos\phi=f(P)$  should refer to curve B. Default values of setting are as shown in curve B.

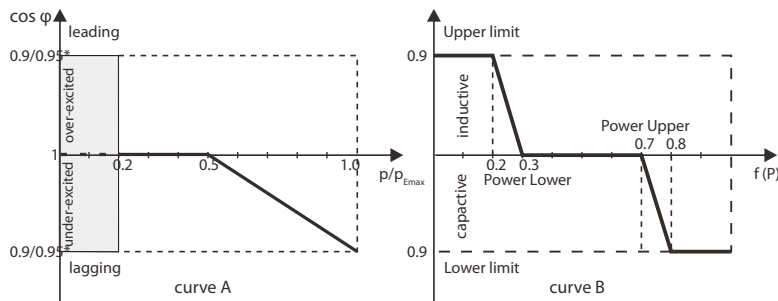

Reactive power control, Reactive standard curve  $Q=f(V)$

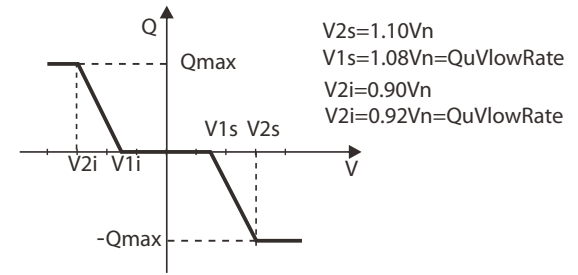

→The way to operate the value :

- a) Just watch the parameter of the mode by short pressing (Λ) and (V).
- b) If you change other mode by short pressing (Λ) and (V), you need return the Power Factor interface by long pressing the (V). Then short press (V) to confirm and enter the Upper Limit. This time you can modify the value by long pressing (Λ); If you only change the parameter of the mode(default), you just long press the (Λ) to modify the value.
- c) After setting, long press the (V) key to confirm and return the previous directly.

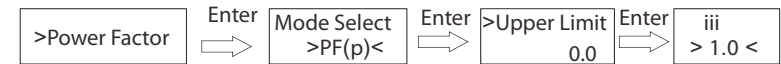

(4) P(u) Function: The device is suitable for Australia if the "Enable" is chosen.

(5) Power limits: User can set the power limit value of the inverter, and the default is 1. If you want to change, please refer to the method bellow. (the same operation to other setting value)

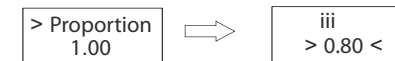

(6) Export Control: With this function the inverter can control energy exported to the grid. Whether having this function is based on user's wishes. The system is disabled by default. The user can choose meter or CT in Mode Select. When choosing meter or CT, means user must install a meter or a CT to monitor energy exported to the grid. There are user value and factory value. The factory value is default which can not be changed by user. The user value setting by installer must be less than the factory value and within the range of 0KW to 6KW.

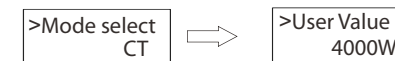



Faults	Diagnosis and solution
SPI Fault	SPI communication fault <ul style="list-style-type: none"> <li>• Disconnect PV+ , PV-, reconnect them.</li> <li>• Or seek help from us, if can not go back to normal state.</li> </ul>
SCI Fault	SCI communication fault <ul style="list-style-type: none"> <li>• Disconnect PV+ , PV-, reconnect them.</li> <li>• Or seek help from us, if can not go back to normal state.</li> </ul>
PV Config Fault	PV Connection Setting Fault <ul style="list-style-type: none"> <li>• Resetting the PV connection</li> <li>• Or seek help from us, if can not go back to normal state.</li> </ul>
Inv EEPROM Fault	Inverter EEPROM fault <ul style="list-style-type: none"> <li>• Disconnect PV+ , PV-, reconnect them.</li> <li>• Or seek help from us, if can not go back to normal state.</li> </ul>
Relay Fault	Relay Fault <ul style="list-style-type: none"> <li>• Disconnect PV+ , PV-, reconnect them.</li> <li>• Or seek help from us, if can not go back to normal state.</li> </ul>
Sample Fault	The detection circuit Fault <ul style="list-style-type: none"> <li>• Disconnect PV+ , PV-, reconnect them.</li> <li>• Or seek help from us, if can not go back to normal state.</li> </ul>
RCD Fault	Residual Current Device Fault <ul style="list-style-type: none"> <li>• Check the impedance of DC input and AC output.</li> <li>• Disconnect PV+ , PV-, reconnect them.</li> <li>• Or seek help from us, if can not go back to normal state.</li> </ul>
AC HCT Fault	AC Current Sensor Fault <ul style="list-style-type: none"> <li>• Disconnect PV+ , PV-, reconnect them.</li> <li>• Or seek help from us, if can not go back to normal state.</li> </ul>
TZ Protect Fault	Over current Fault. <ul style="list-style-type: none"> <li>• Wait for a while to check if go back to normal status.</li> <li>• Disconnect PV+ , PV-, reconnect them.</li> <li>• Or seek help from us, if can not go back to normal state.</li> </ul>
Grid Lost Fault	Grid is Lost. <ul style="list-style-type: none"> <li>• System will reconnect if the utility is back to normal.</li> <li>• Or seek help from us.</li> </ul>
Grid Volt Fault	Grid Voltage Out of Range <ul style="list-style-type: none"> <li>• System will reconnect if the utility is back to normal.</li> <li>• Or seek help from us.</li> </ul>
Grid Freq Fault	Grid Voltage out of range <ul style="list-style-type: none"> <li>• System will reconnect if the utility is back to normal.</li> <li>• Or seek help from us.</li> </ul>
PLL Lost Fault	The Grid is Not Good. <ul style="list-style-type: none"> <li>• System will reconnect if the utility is back to normal.</li> <li>• Or seek help from us.</li> </ul>

Faults	Diagnosis and solution
Bus Volt Fault	Bus Voltage out of Normal Range. <ul style="list-style-type: none"> <li>• Disconnect PV+ , PV-, reconnect them.</li> <li>• Check if the PV input is within the range of the inverter.</li> <li>• Or seek help from us, if can not go back to normal state.</li> </ul>
Inv OCP Fault	Inverter over current protection fault <ul style="list-style-type: none"> <li>• Wait for a while to check if back to normal.</li> <li>• Or seek for help from us.</li> </ul>
DCI OCP Fault	DCI over current protection Fault. <ul style="list-style-type: none"> <li>• Wait for a while to check if back to normal.</li> <li>• Or seek for help from us.</li> </ul>
PV Volt Fault	PV Voltage Fault <ul style="list-style-type: none"> <li>• Check the output of the PV voltage.</li> <li>• Or seek for help from us.</li> </ul>
Isolation Fault	Isolation Fault <ul style="list-style-type: none"> <li>• Check the connection of the inverter.</li> <li>• Or seek for help from us.</li> </ul>
Temp Over Fault	Temperature over the limitation <ul style="list-style-type: none"> <li>• Check if the fan is running normally.</li> <li>• Check if the envirement temperature is over limitation.</li> <li>• Or seek help from us.</li> </ul>
RC Fault	Residual Current Fault. <ul style="list-style-type: none"> <li>• Check if cables and PE conductors are connected properly.</li> <li>• Wait for a while to check if back to normal.</li> <li>• Or seek for help from us.</li> </ul>
Other device Fault	Other device fault. <ul style="list-style-type: none"> <li>• Turn off the PV and grid, reconnect them,</li> <li>• Or seek for help from us if can not back to normal.</li> </ul>
SW OCP Fault	Over current fault detected by software. <ul style="list-style-type: none"> <li>• Turn off the PV and grid, reconnect them,</li> <li>• Or seek for help from us if can not back to normal.</li> </ul>
Mgr EEPROM Fault	Manager EEPROM Fault. <ul style="list-style-type: none"> <li>• Turn off the PV and grid, reconnect them,</li> <li>• Or seek for help from us if can not back to normal.</li> </ul>
AC10M Volt Fault	AC10Minute overvoltage Fault <ul style="list-style-type: none"> <li>• System will reconnect if the utility is back to normal.</li> <li>• Or seek help from us.</li> </ul>
Meter Fault	Meter Fault <ul style="list-style-type: none"> <li>• Check the the Meter connection with the inverter.</li> <li>• Or seek help from us.</li> </ul>
Earth Fault	Earth Fault <ul style="list-style-type: none"> <li>• Check the the connection with the inverter.</li> <li>• Or seek help from us.</li> </ul>



### 7.2 Routine Maintenance

Inverters do not need any maintenance or correction in most cases, but if the inverter often loses power due to overheating, this can be attributed to the following reason:

The cooling fins on the rear of the inverter are covered by dirt.

Clean the cooling fins with a soft dry cloth or brush if necessary.

Only trained and authorized professional personnel who are familiar with the requirements of safety is allowed to perform servicing and maintenance work.

### Safety checks

Safety checks should be performed at least every 12 months by manufacturer's qualified person who has adequate training, knowledge, and practical experience to perform these tests. The data should be recorded in an equipment log. If the device is not functioning properly or fails any of test, the device has to be repaired. For safety check details, refer to this section 2 Safety instruction and EC Directives on this manual.

### Maintain periodically

Only qualified person may perform the following works.

During the process of using the inverter, the manage person shall examine and maintain the machine regularly. The concrete operations are as follows.

- 1) Check that if the cooling fins on the rear of the inverter are covered by dirt, and the machine should be cleaned and absorbed dust when necessary. This work shall be check time to time.
- 2) Check that if the indicators of the inverter are in normal state, check if the keys of the inverter are in normal state, check if the display of the inverter is normal. This check should be performed at least every 6 months.
- 3) Check that if the input and output wires are damaged or aged. This check should be performed at least every 6 months.
- 4) Check whether the ground terminal and ground cable are securely connected and all terminals and ports are properly sealed every 12 months
- 5) You should get the inverter panels cleaned and their security checked at least every 6 months.

## 8 Decommissioning

### 8.1 Dismantling the Inverter

- Turn off the AC and DC switches of the inverter system.
- Wait for 5 minutes for de-energizing.
- Disconnect the DC AC output, communication and other cables.
- Remove the inverter from the bracket.
- Remove the bracket if necessary.



#### WARNING!

Before dismantling the inverter, please be sure to disconnect the DC switch, and then unplug the PV and AC cables, otherwise it will lead to an electric shock hazard.

### 8.2 Packaging

If possible, please pack the inverter with the original packaging.

If it is no longer available, you can also use an equivalent carton that meets the following requirements.

- Suitable for loads more than 30 kg.
- With handle.
- Can be fully closed.

### 8.3 Storage and Transportation

Store the inverter in dry place where ambient temperatures are always between -30 °C - +70 °C. Take care of the inverter during the storage and transportation, keep less than 4 cartons in one stack.

When the inverter or other related components need to be disposed. Have it carried out according to local waste handling regulations. Please be sure to deliver wasted inverters and packing materials to certain site, which can assist relevant department to dispose and recycle.

### 8.4 Disposing of the X1-Boost

If the X1-Boost service life expires, dispose of it according to the local disposal rules for electrical equipment waste.

## 9 Disclaimer

The inverters are transported, used and operated under limited condition, such as environmental, electrical etc. We shall not be liable to provide the service, technical support or compensation under conditions listed below, including but not limited to:

- Inverter is damaged or broken by force majeure (such as earthquake, flooding, thunderstorm, lightning, fire hazard, volcanic eruption etc.).
- Inverter's warranty is expired and doesn't buy extended warranty.
- Can't provide the inverter's SN, warranty card or invoice.
- Inverter is damaged by man-made cause.
- Inverter is used or operated against any items in local policy.
- Inverter's installation, configuration, commissioning doesn't follow the requirements mentioned in this manual.
- Inverter is installed, refitted or operated in improper ways mentioned in this manual without authority from us.
- Inverter is installed, operated under improper environment or electrical condition mentioned in this manual without authority from us.
- Inverter is changed, updated or disassembled on hardware or software without authority from us.
- Obtain the communication protocol from other illegal channels.
- Build monitoring, control system without authority from us.

We will keep right to explain all the contents in this user manual.

## 10 Commissioning

- Please select Australia Region A, B, C for power quality response modes and grid protection settings during commissioning.
- You can adjust setpoints for power quality response modes and grid protection settings if required.

After commissioning, you can view the following settings through the LCD of the inverter after commissioning:

- Firmware version
- Region settings (and setpoints) for grid protection settings
- Region settings (and setpoints) for power quality response modes.



### NOTE!

Once settings are selected at commissioning they are locked to view only.



### NOTE!

Password should not be readily available – if you need that, you can find the password that either in a separate maintenance/service manual or available from manufacturer/importer upon request.

# Warranty Registration Form



## For Customer (Compulsory)

Name ..... Country .....

Phone Number ..... Email .....

Address .....

State ..... Zip Code .....

Product Serial Number .....

Date of Commissioning .....

Installation Company Name .....

Installer Name ..... Electrician License No. ....

## For Installer

### Module ( If Any )

Module Brand .....

Module Size(W) .....

Number of String ..... Number of Panel Per String .....

### Battery ( If Any )

Battery Type .....

Brand .....

Number of Battery Attached .....

Date of Delivery ..... Signature .....

Please visit our warranty website: <https://www.solaxcloud.com/#/warranty> to complete the online warranty registration or use your mobile phone to scan the QR code to register.

For more detailed warranty terms, please visit SolaX official website: [www.solaxpower.com](http://www.solaxpower.com) to check it.





PLEASE REGISTER THE WARRANTY  
IMMEDIATELY AFTER INSTALLATION!  
GET YOUR WARRANTY CERTIFICATE  
FROM SOLAX!  
KEEP YOUR INVERTER ONLINE & WIN  
SOLAX POINTS!

1

Open your camera app and point your device at the QR code



2

Wait for the camera to recognize the QR code



3

Click banner or notification when it appears on the screen



4

Warranty registration page will be loaded automatically

